

When printed
at the correct
size, this box
will measure
1in / 26mm
square

BEA'S GARDEN

Anne Varley page 26

APPLIQUÉ TEMPLATES AND LAYOUT



ACTUAL SIZE

PLEASE NOTE: Templates DO NOT include seam allowances.

PART A1

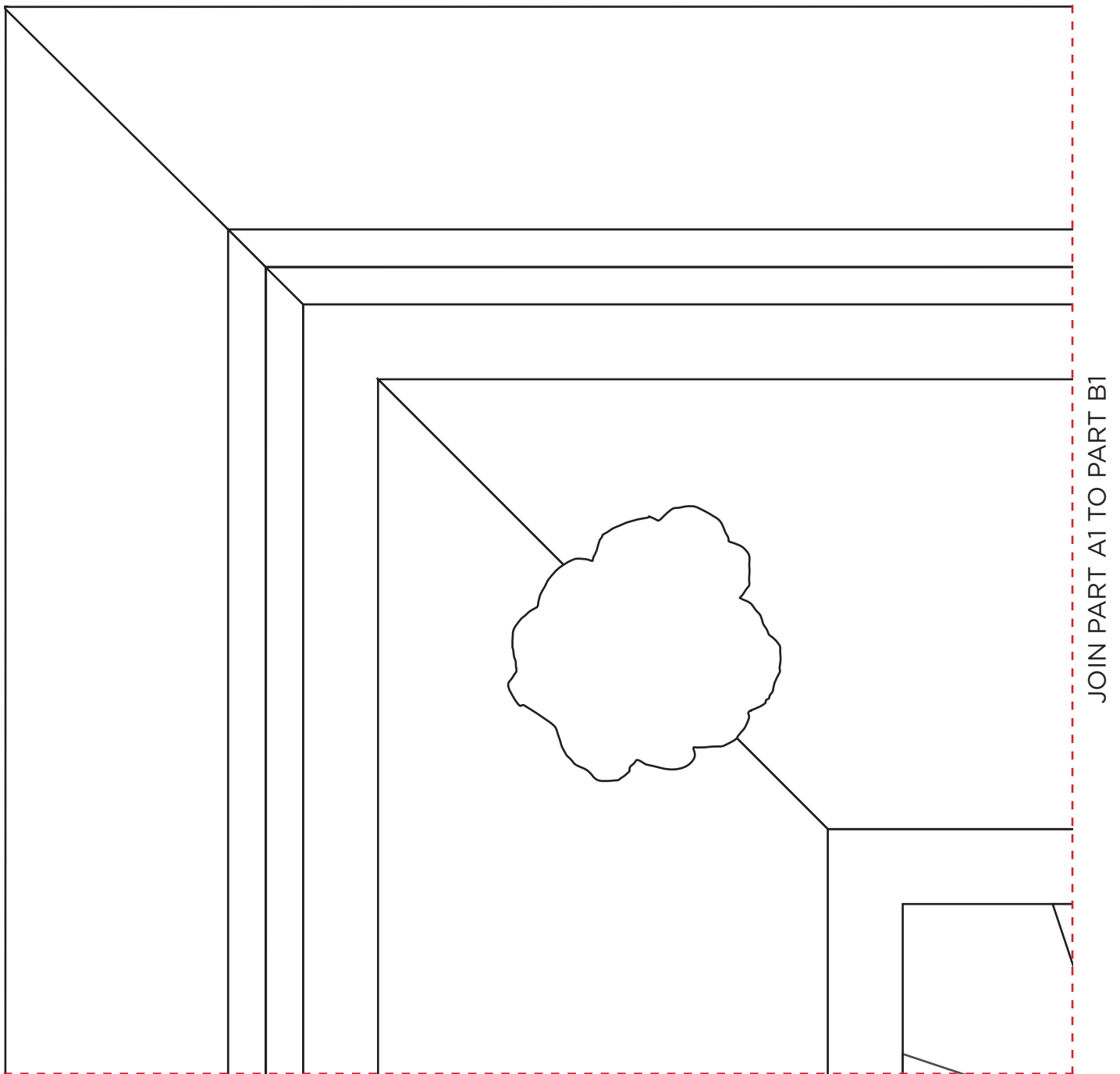

JOIN PART A1 TO PART B1

JOIN PART A1 TO PART A2

When printed at the correct size, this box will measure 1in / 26mm square

BEA'S GARDEN

Anne Varley page 26

APPLIQUÉ TEMPLATES AND LAYOUT



ACTUAL SIZE

PLEASE NOTE: Templates DO NOT include seam allowances.

PART B1

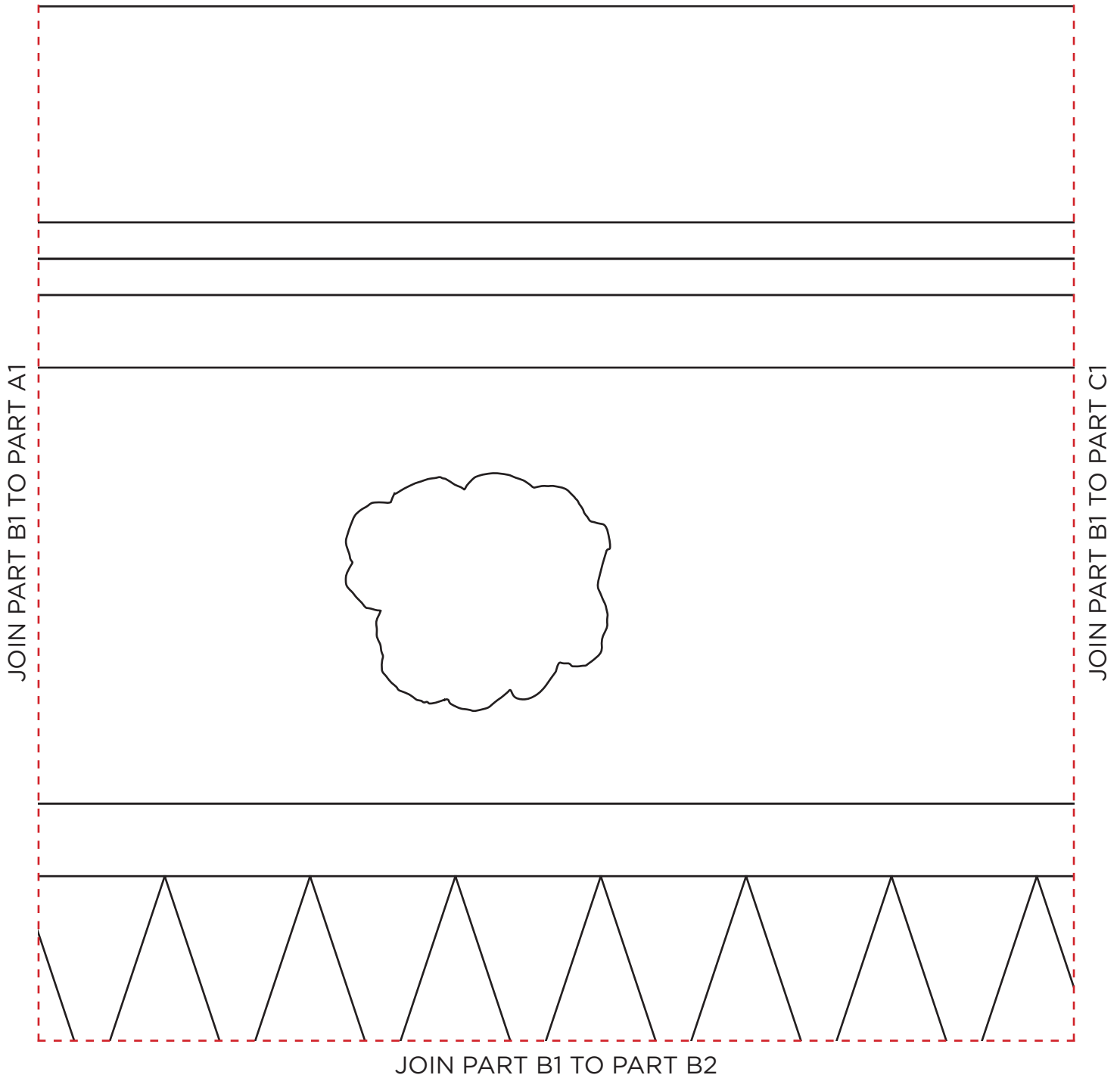

Thank you for making this project from Today's Quilter. The copyright for these templates belongs to the designer of the project. Please don't re-sell or distribute their work without permission. Please do not make any part of the templates or instructions available to others through your website or a third party website, or copy it multiple times without our permission. Copyright law protects creative work and unauthorised copying is illegal. We appreciate your help.

When printed at the correct size, this box will measure 1in / 26mm square

BEA'S GARDEN

Anne Varley page 26

APPLIQUÉ TEMPLATES AND LAYOUT



ACTUAL SIZE

PLEASE NOTE: Templates DO NOT include seam allowances.

PART C1

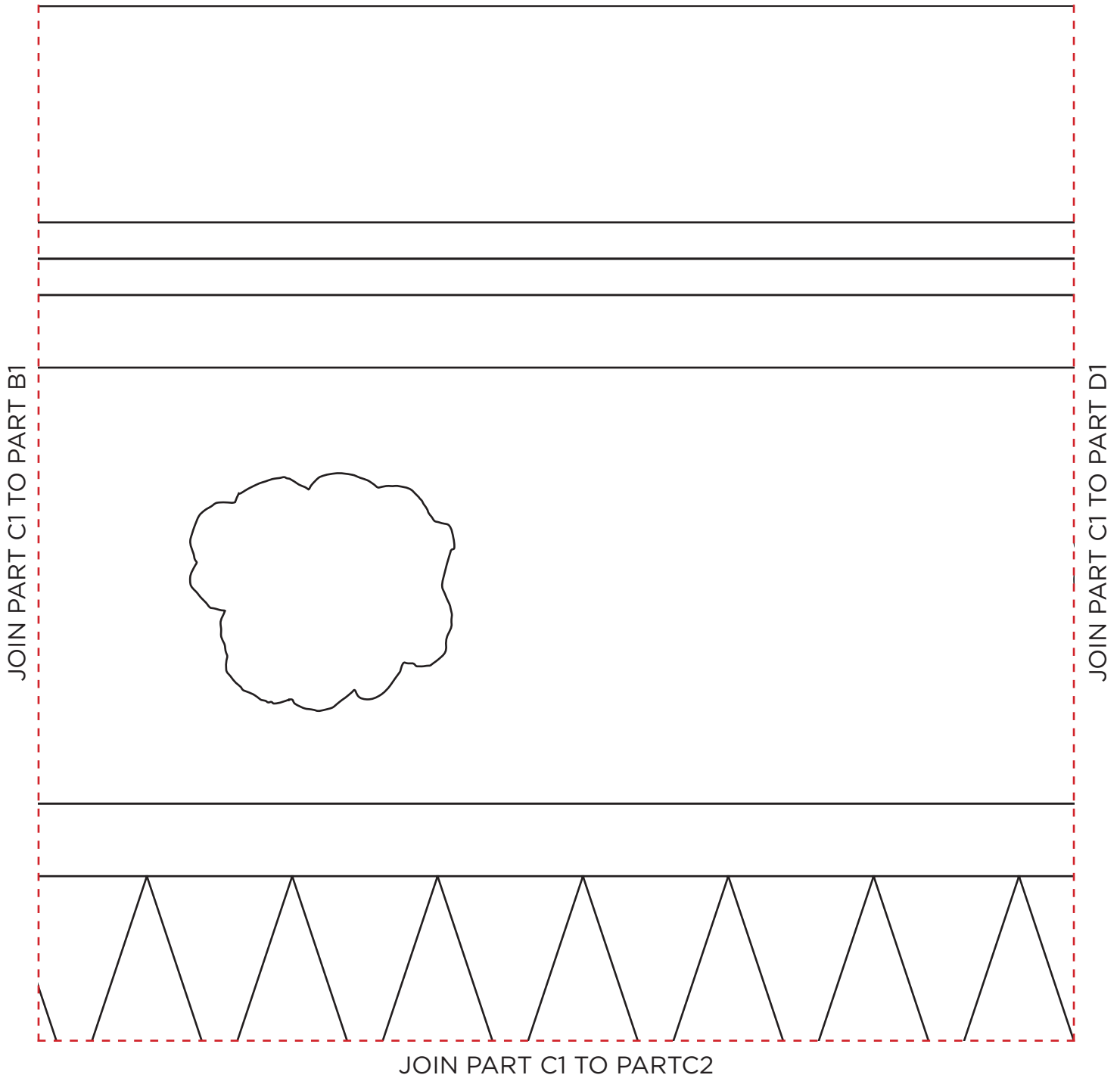

When printed
at the correct
size, this box
will measure
1in / 26mm
square

BEA'S GARDEN

Anne Varley page 26

APPLIQUÉ TEMPLATES AND LAYOUT



ACTUAL SIZE

PLEASE NOTE: Templates DO NOT include seam allowances.

PART D1

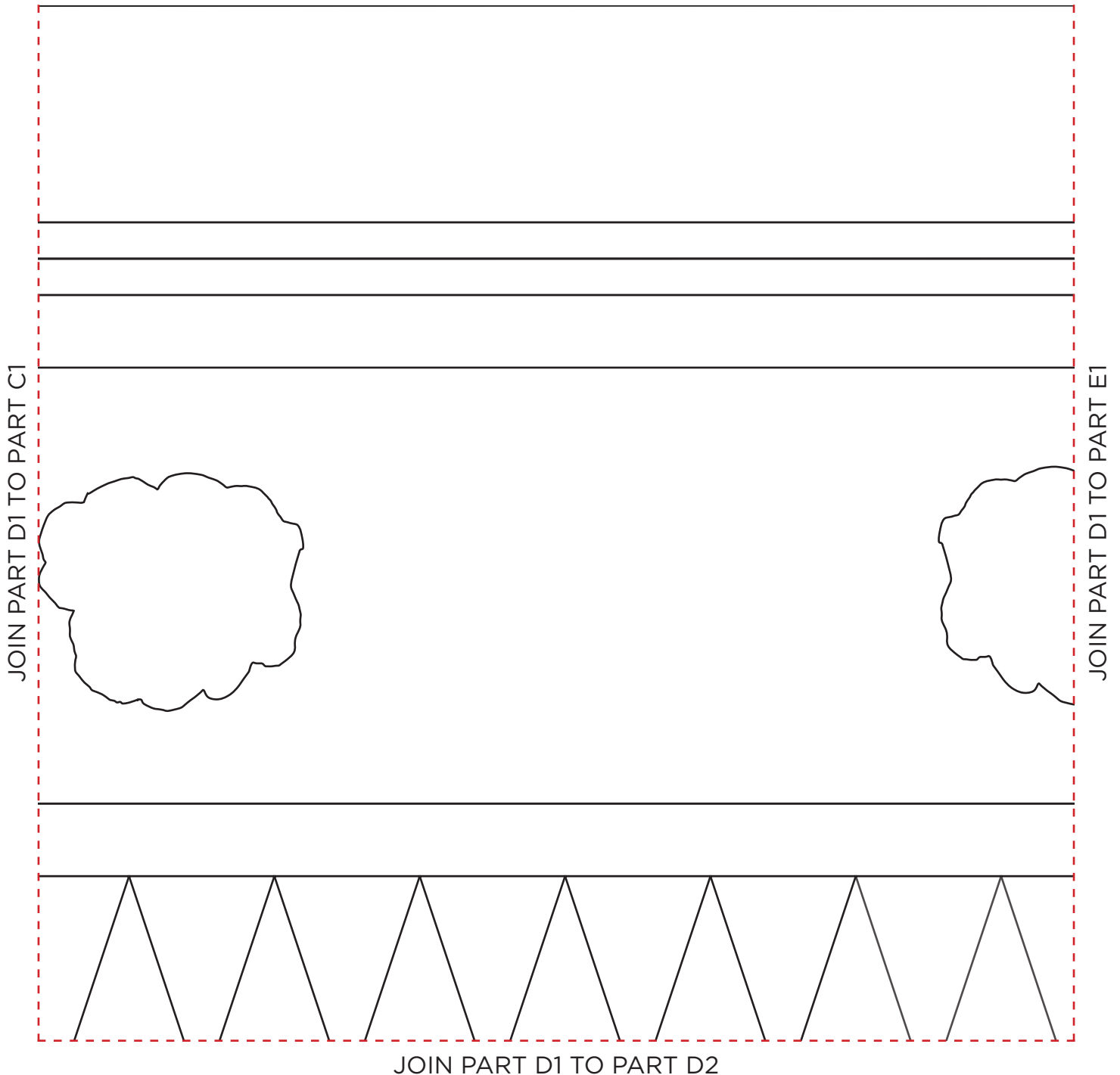

When printed at the correct size, this box will measure 1in / 26mm square

BEA'S GARDEN

Anne Varley page 26

APPLIQUÉ TEMPLATES AND LAYOUT



ACTUAL SIZE

PLEASE NOTE: Templates DO NOT include seam allowances.

PART E1

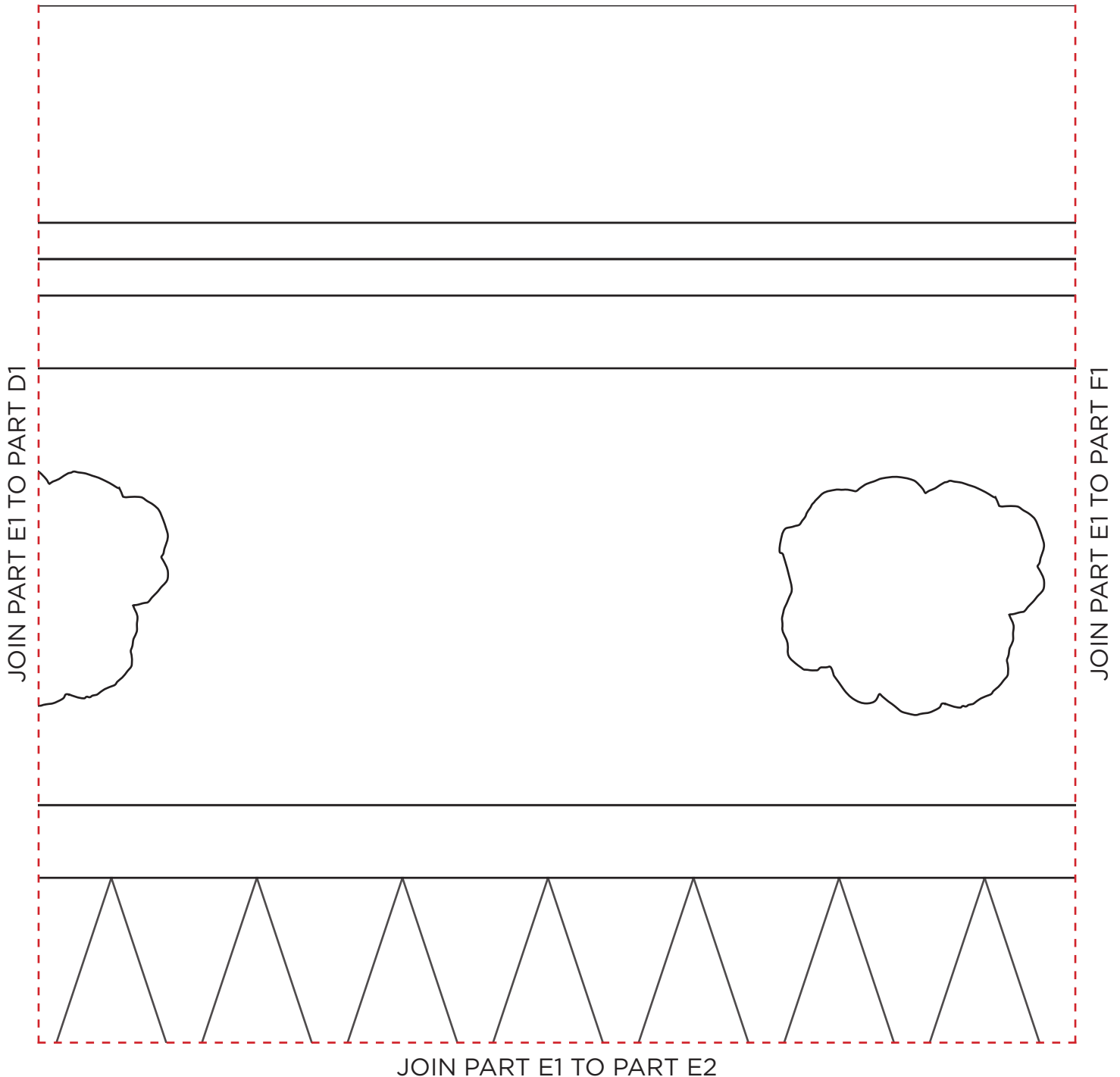

When printed at the correct size, this box will measure 1in / 26mm square

BEA'S GARDEN

Anne Varley page 26

APPLIQUÉ TEMPLATES AND LAYOUT



ACTUAL SIZE

PLEASE NOTE: Templates DO NOT include seam allowances.

PART F1

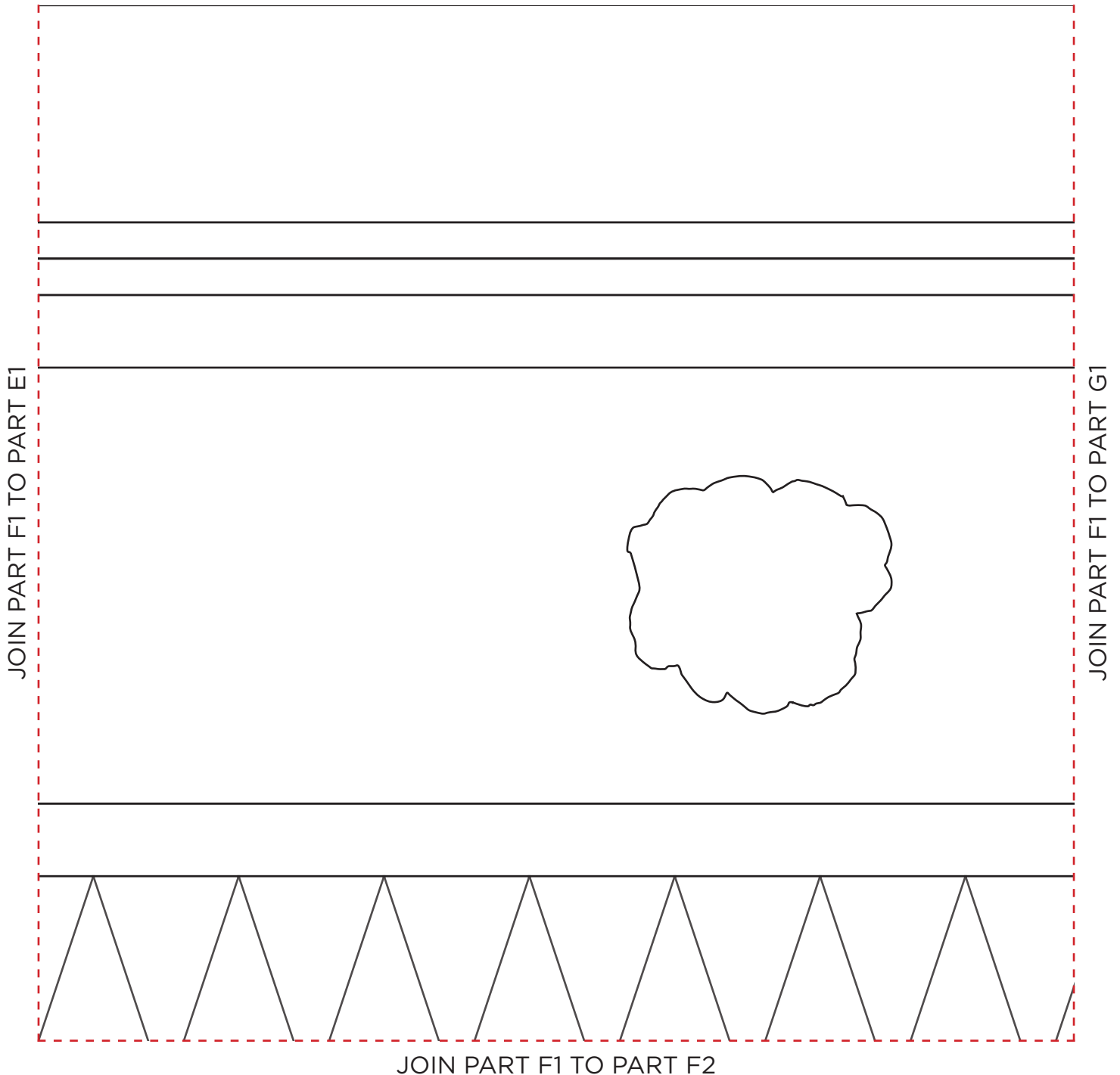

Thank you for making this project from Today's Quilter. The copyright for these templates belongs to the designer of the project. Please don't re-sell or distribute their work without permission. Please do not make any part of the templates or instructions available to others through your website or a third party website, or copy it multiple times without our permission. Copyright law protects creative work and unauthorised copying is illegal. We appreciate your help.

When printed at the correct size, this box will measure 1in / 26mm square

BEA'S GARDEN

Anne Varley page 26

APPLIQUÉ TEMPLATES AND LAYOUT



ACTUAL SIZE

PLEASE NOTE: Templates DO NOT include seam allowances.

PART G1

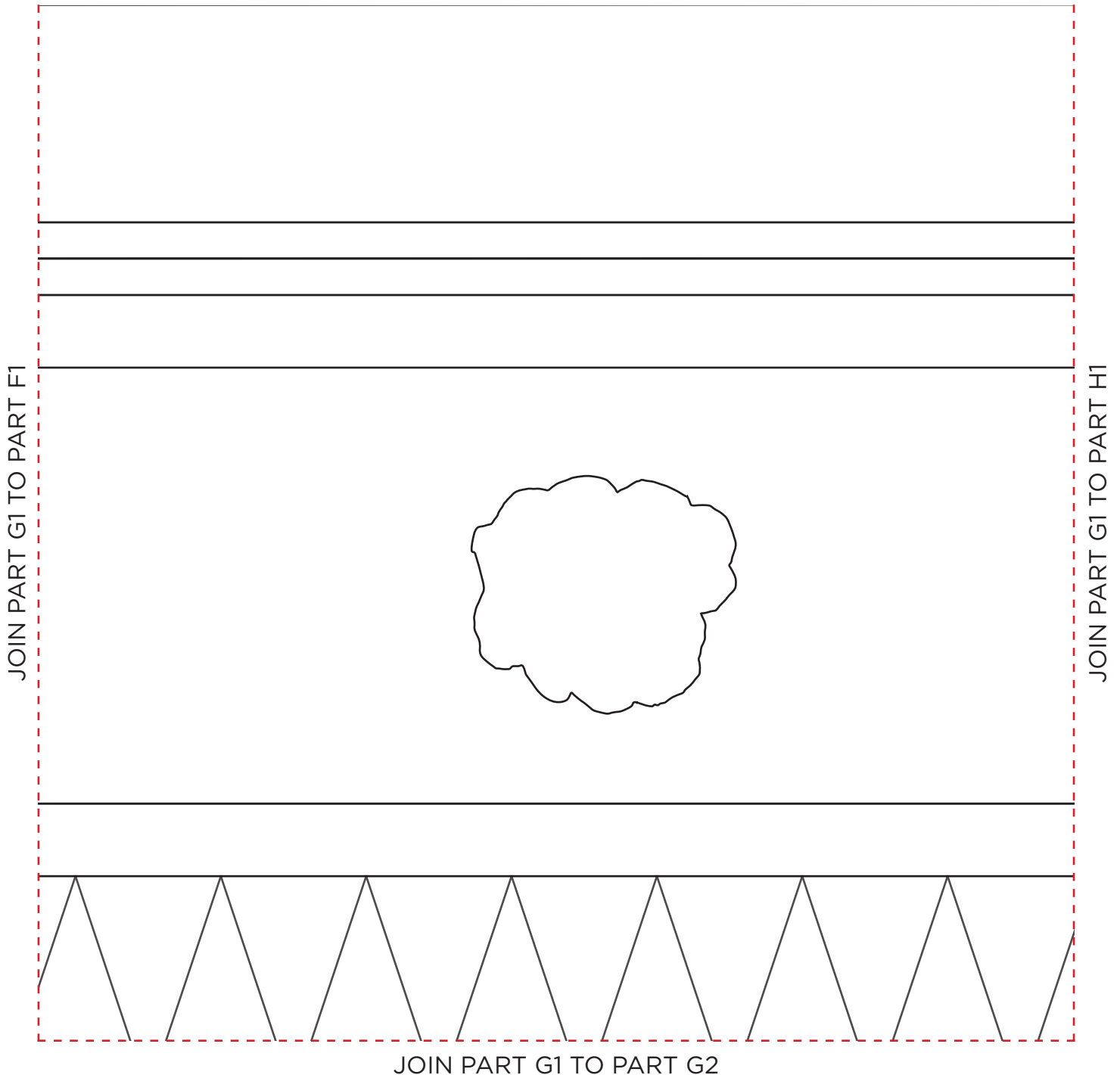

When printed
at the correct
size, this box
will measure
1in / 26mm
square

BEA'S GARDEN

Anne Varley page 26

APPLIQUÉ TEMPLATES AND LAYOUT



ACTUAL SIZE

PLEASE NOTE: Templates DO NOT include seam allowances.

PART H1

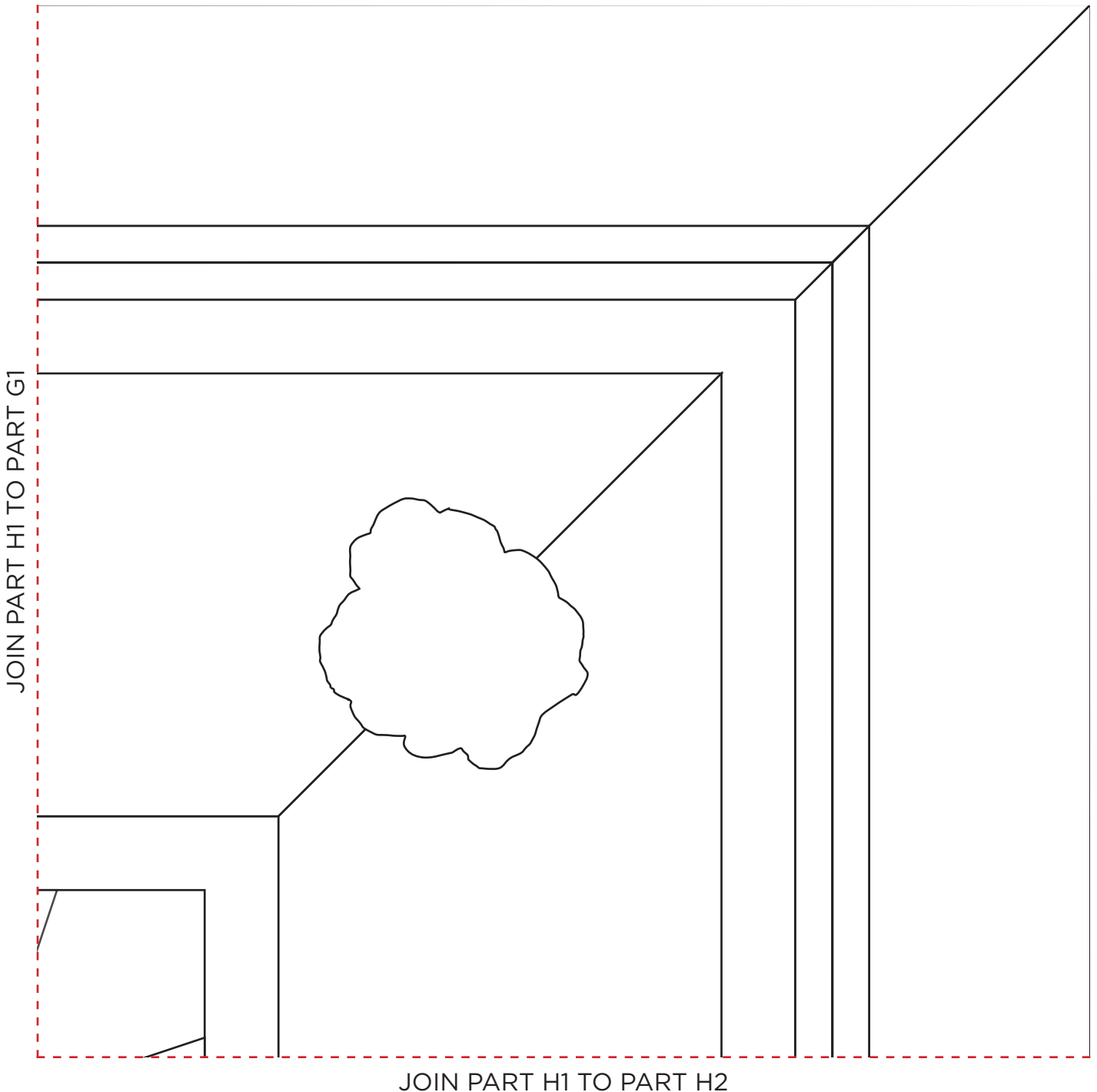

Thank you for making this project from Today's Quilter. The copyright for these templates belongs to the designer of the project. Please don't re-sell or distribute their work without permission. Please do not make any part of the templates or instructions available to others through your website or a third party website, or copy it multiple times without our permission. Copyright law protects creative work and unauthorised copying is illegal. We appreciate your help.

When printed
at the correct
size, this box
will measure
1in / 26mm
square

BEA'S GARDEN

Anne Varley page 26

APPLIQUÉ TEMPLATES AND LAYOUT



ACTUAL SIZE

PLEASE NOTE: Templates DO NOT include seam allowances.

PART A2

JOIN PART A2 TO PART A1

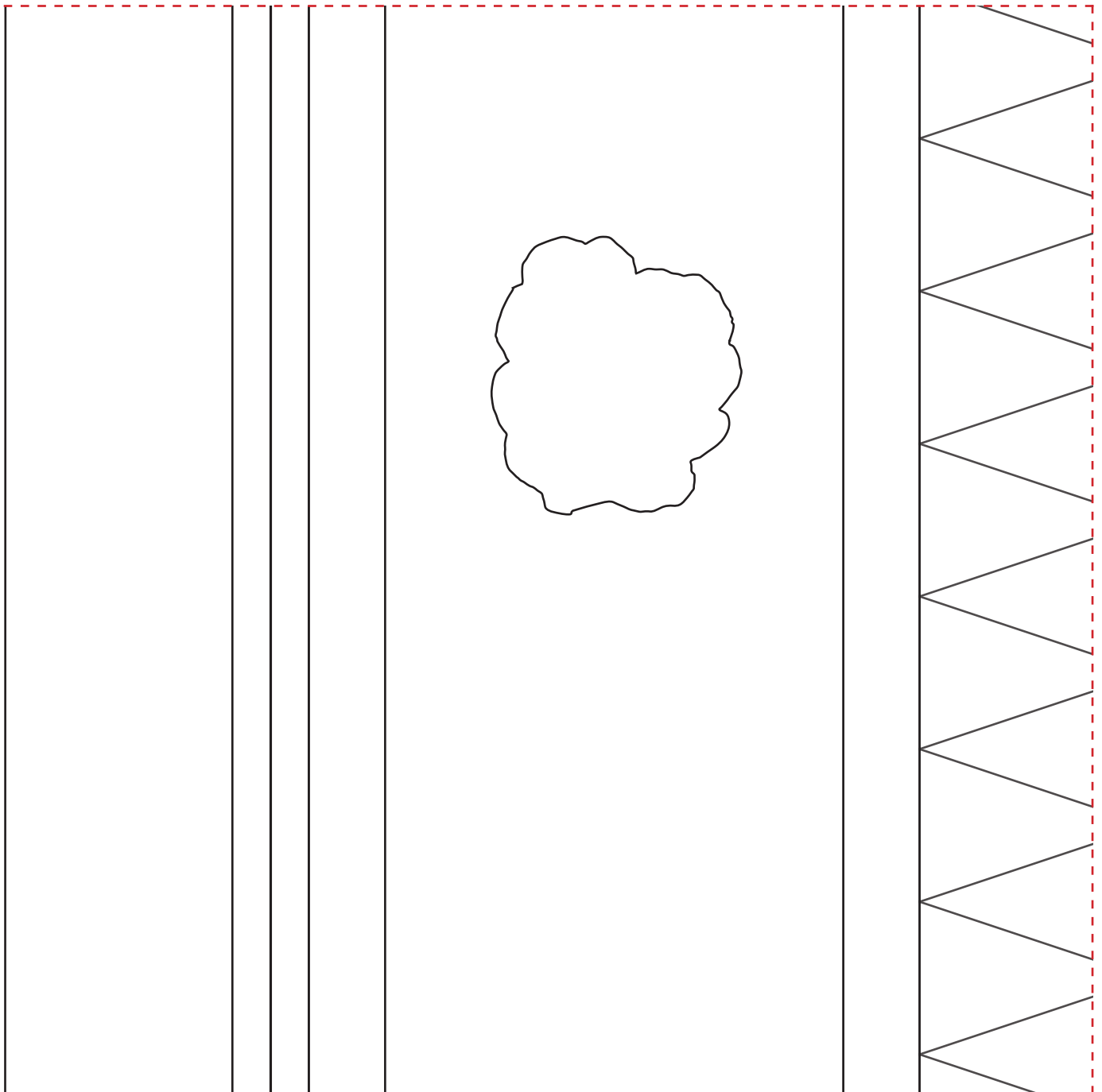

JOIN PART A2 TO PART B2

JOIN PART A2 TO PART A3

When printed
at the correct
size, this box
will measure
1in / 26mm
square

BEA'S GARDEN

Anne Varley page 26

APPLIQUÉ TEMPLATES AND LAYOUT



ACTUAL SIZE

PLEASE NOTE: Templates DO NOT include seam allowances.

PART B2

JOIN PART B2 TO PART B1

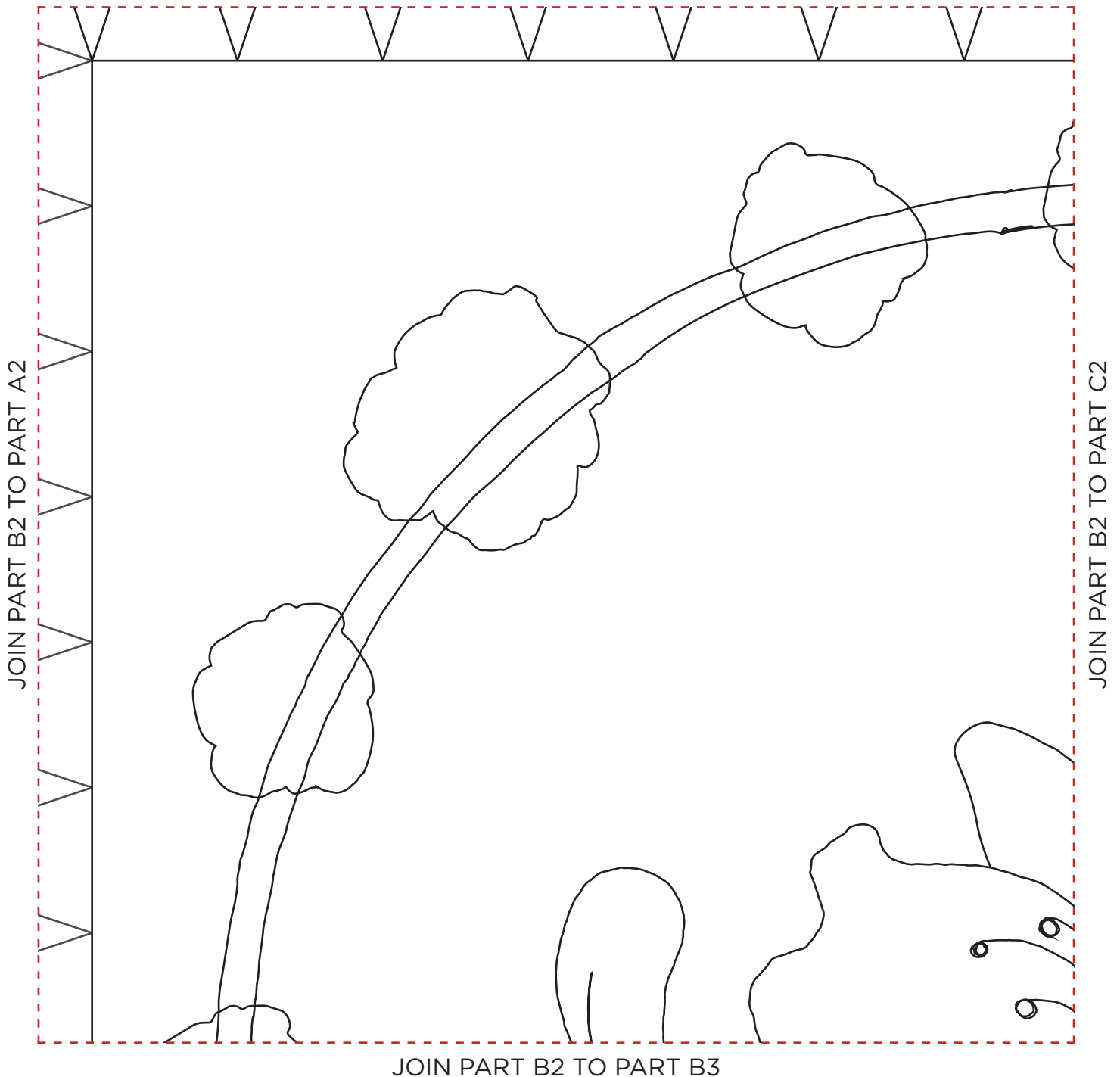

JOIN PART B2 TO PART B3

Thank you for making this project from Today's Quilter. The copyright for these templates belongs to the designer of the project. Please don't re-sell or distribute their work without permission. Please do not make any part of the templates or instructions available to others through your website or a third party website, or copy it multiple times without our permission. Copyright law protects creative work and unauthorised copying is illegal. We appreciate your help.

TODAY'S
QUILTER
Create beautiful quilts for your home

When printed
at the correct
size, this box
will measure
1in / 26mm
square

BEA'S GARDEN

Anne Varley page 26

APPLIQUÉ TEMPLATES AND LAYOUT



ACTUAL SIZE

PLEASE NOTE: Templates DO NOT include seam allowances.

PART C2

JOIN PART C2 TO PART C1

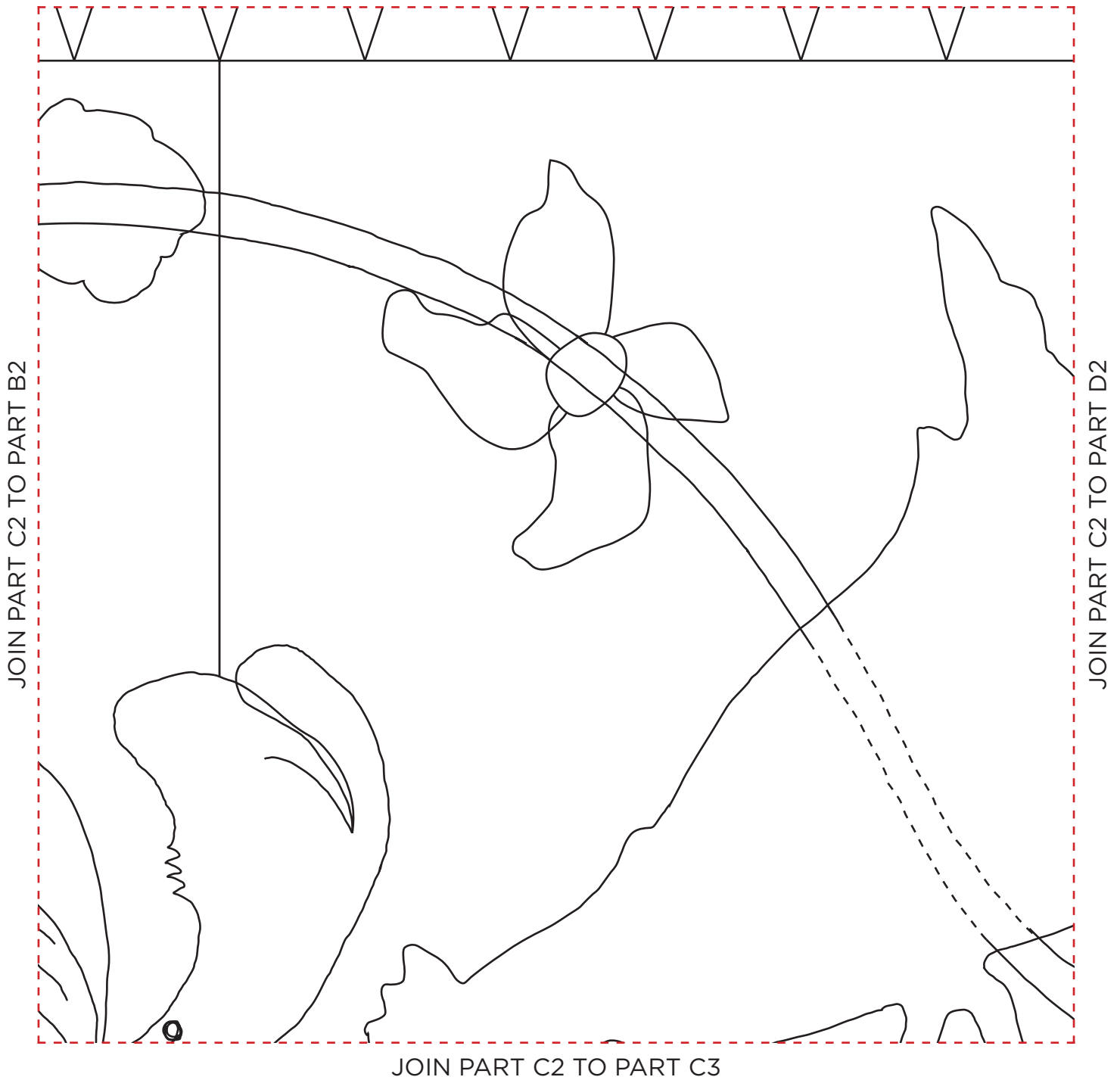

JOIN PART C2 TO PART C3

When printed
at the correct
size, this box
will measure
1in / 26mm
square

BEA'S GARDEN

Anne Varley page 26

APPLIQUÉ TEMPLATES AND LAYOUT



ACTUAL SIZE

PLEASE NOTE: Templates DO NOT include seam allowances.

PART D2

JOIN PART D2 TO PART D1



JOIN PART D2 TO PART D3

Thank you for making this project from Today's Quilter. The copyright for these templates belongs to the designer of the project. Please don't re-sell or distribute their work without permission. Please do not make any part of the templates or instructions available to others through your website or a third party website, or copy it multiple times without our permission. Copyright law protects creative work and unauthorised copying is illegal. We appreciate your help.

When printed
at the correct
size, this box
will measure
1in / 26mm
square

BEA'S GARDEN

Anne Varley page 26

APPLIQUÉ TEMPLATES AND LAYOUT



ACTUAL SIZE

PLEASE NOTE: Templates DO NOT include seam allowances.

PART E2

JOIN PART E2 TO PART E1

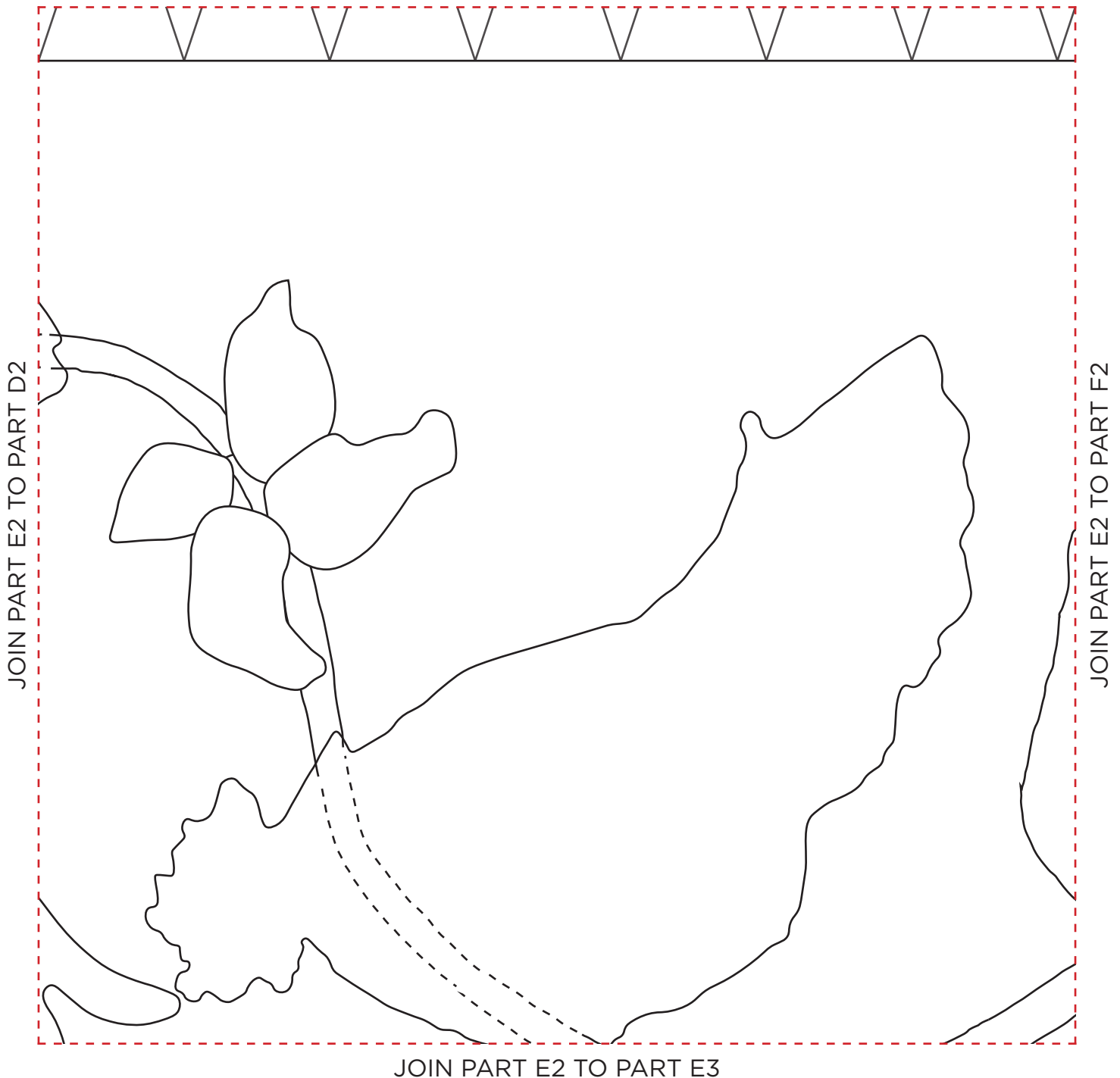

When printed
at the correct
size, this box
will measure
1in / 26mm
square

BEA'S GARDEN

Anne Varley page 26

APPLIQUÉ TEMPLATES AND LAYOUT



ACTUAL SIZE

PLEASE NOTE: Templates DO NOT include seam allowances.

PART F2

JOIN PART F2 TO PART F1

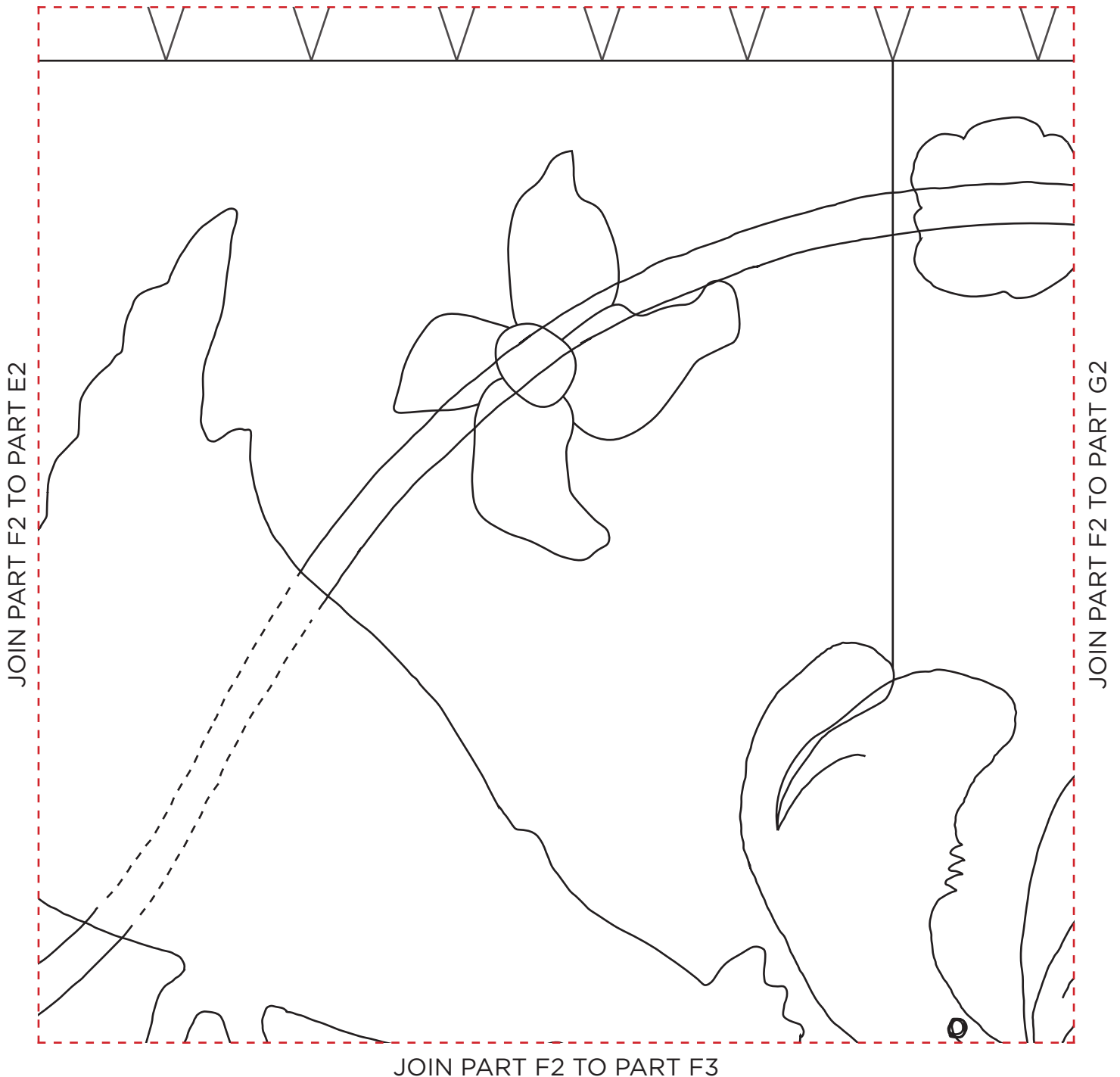

JOIN PART F2 TO PART F3

Thank you for making this project from Today's Quilter. The copyright for these templates belongs to the designer of the project. Please don't re-sell or distribute their work without permission. Please do not make any part of the templates or instructions available to others through your website or a third party website, or copy it multiple times without our permission. Copyright law protects creative work and unauthorised copying is illegal. We appreciate your help.

TODAY'S
QUILTER
Create beautiful quilts for your home

When printed
at the correct
size, this box
will measure
1in / 26mm
square

BEA'S GARDEN

Anne Varley page 26

APPLIQUÉ TEMPLATES AND LAYOUT



ACTUAL SIZE

PLEASE NOTE: Templates DO NOT include seam allowances.

PART G2

JOIN PART G2 TO PART G1

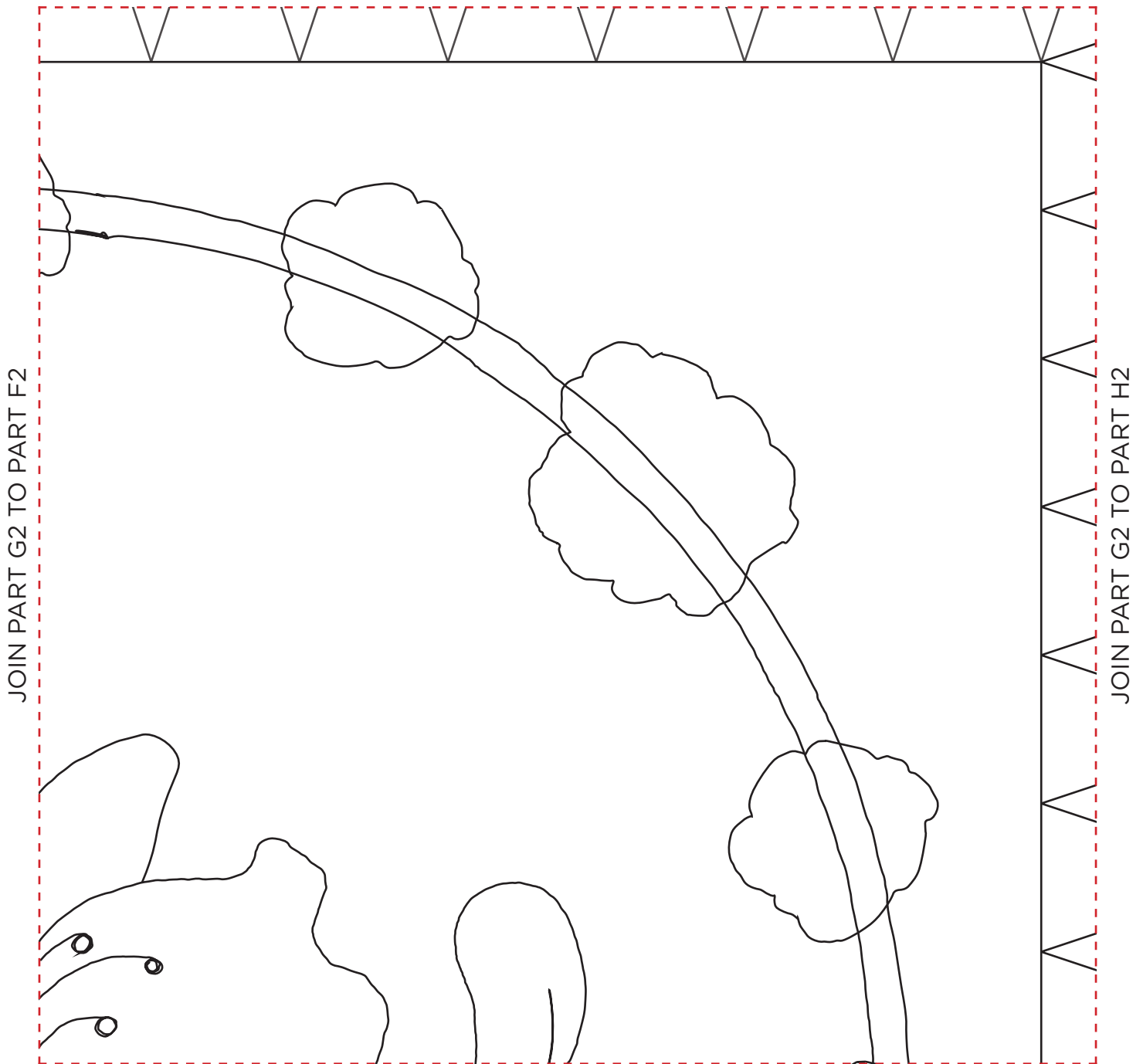

JOIN PART G2 TO PART G3

Thank you for making this project from Today's Quilter. The copyright for these templates belongs to the designer of the project. Please don't re-sell or distribute their work without permission. Please do not make any part of the templates or instructions available to others through your website or a third party website, or copy it multiple times without our permission. Copyright law protects creative work and unauthorised copying is illegal. We appreciate your help.

TODAY'S
QUILTER
Create beautiful quilts for your home

When printed
at the correct
size, this box
will measure
1in / 26mm
square

BEA'S GARDEN

Anne Varley page 26

APPLIQUÉ TEMPLATES AND LAYOUT



ACTUAL SIZE

PLEASE NOTE: Templates DO NOT include seam allowances.

PART H2

JOIN PART H2 TO PART H1

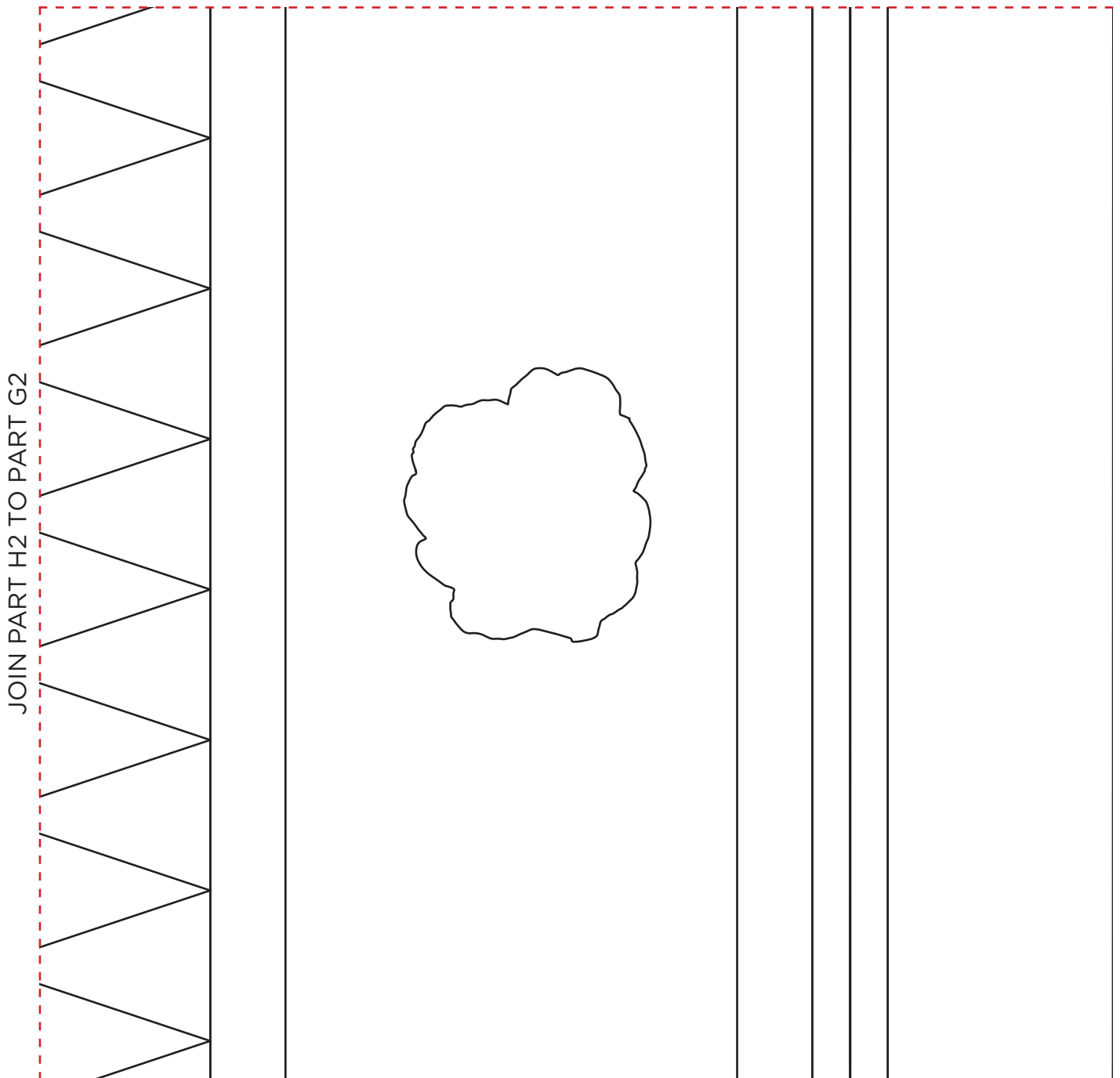

JOIN PART H2 TO PART H3

When printed
at the correct
size, this box
will measure
1in / 26mm
square

BEA'S GARDEN

Anne Varley page 26

APPLIQUÉ TEMPLATES AND LAYOUT



ACTUAL SIZE

PLEASE NOTE: Templates DO NOT include seam allowances.

PART A3

JOIN PART A3 TO PART A2

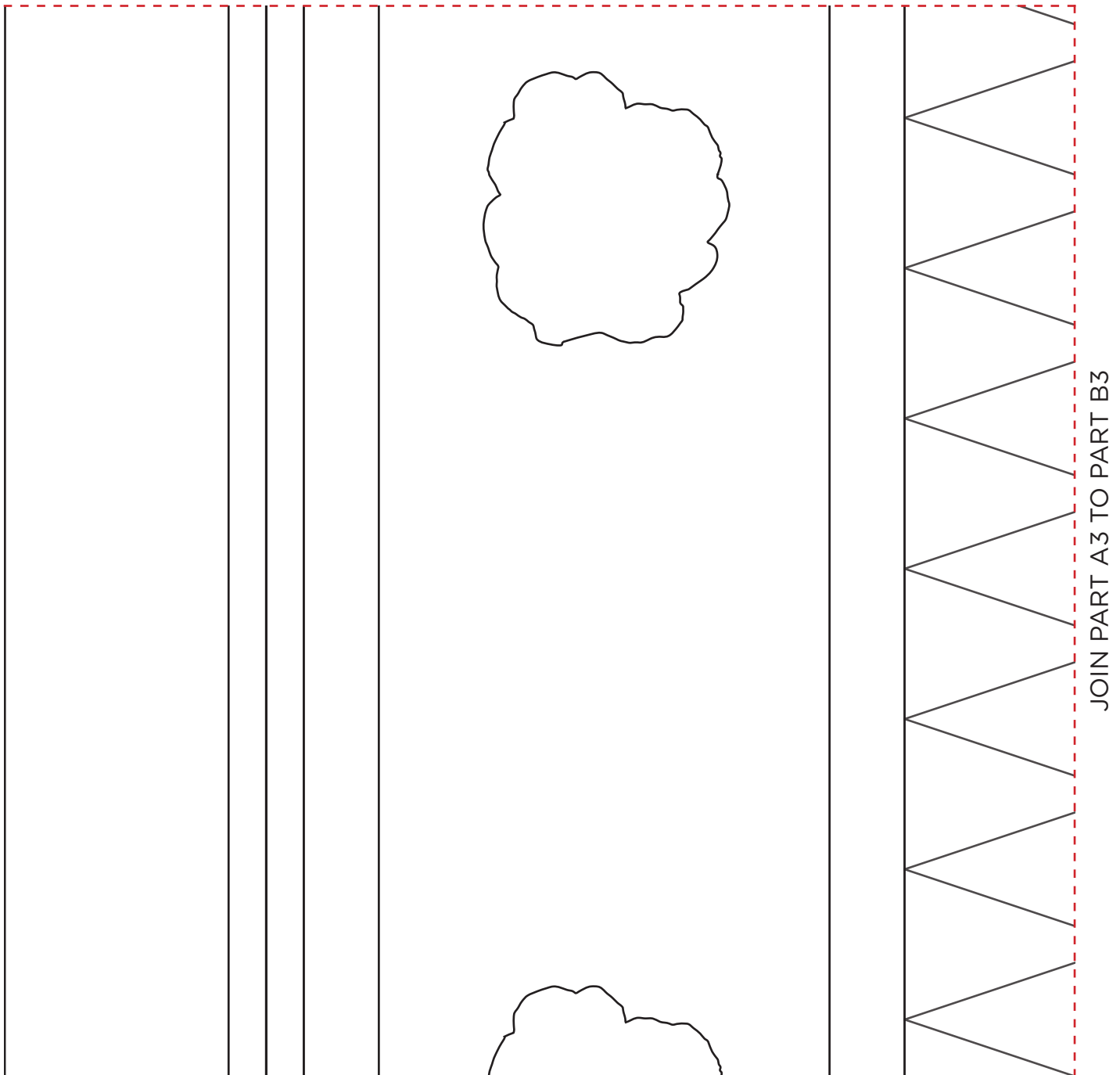

JOIN PART A3 TO PART A4

When printed
at the correct
size, this box
will measure
1in / 26mm
square

BEA'S GARDEN

Anne Varley page 26

APPLIQUÉ TEMPLATES AND LAYOUT



ACTUAL SIZE

PLEASE NOTE: Templates DO NOT include seam allowances.

PART B3

JOIN PART B3 TO PART B2

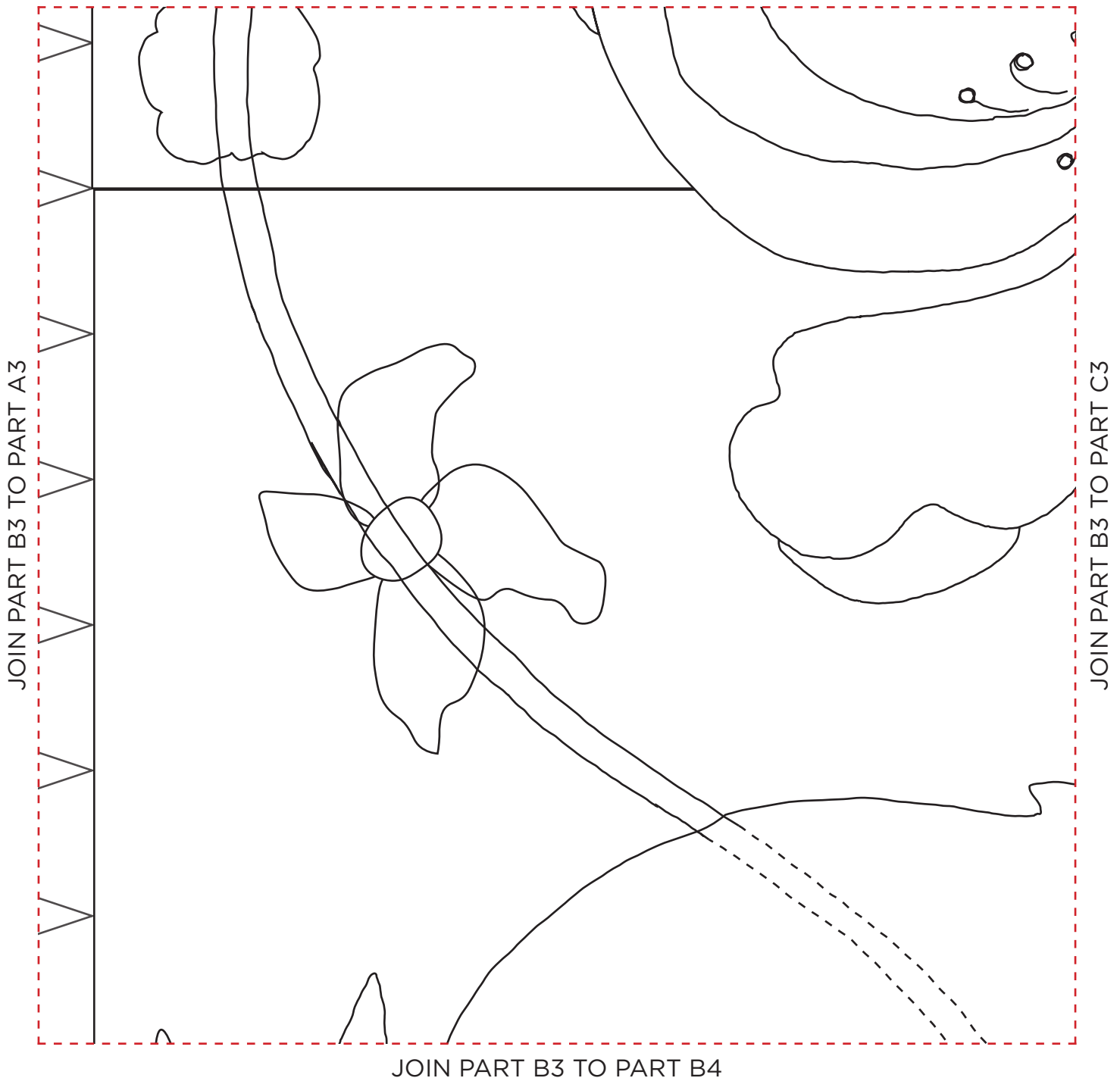

Thank you for making this project from Today's Quilter. The copyright for these templates belongs to the designer of the project. Please don't re-sell or distribute their work without permission. Please do not make any part of the templates or instructions available to others through your website or a third party website, or copy it multiple times without our permission. Copyright law protects creative work and unauthorised copying is illegal. We appreciate your help.

When printed
at the correct
size, this box
will measure
1in / 26mm
square

BEA'S GARDEN

Anne Varley page 26

APPLIQUÉ TEMPLATES AND LAYOUT



ACTUAL SIZE

PLEASE NOTE: Templates DO NOT include seam allowances.

PART C3

JOIN PART C3 TO PART C2

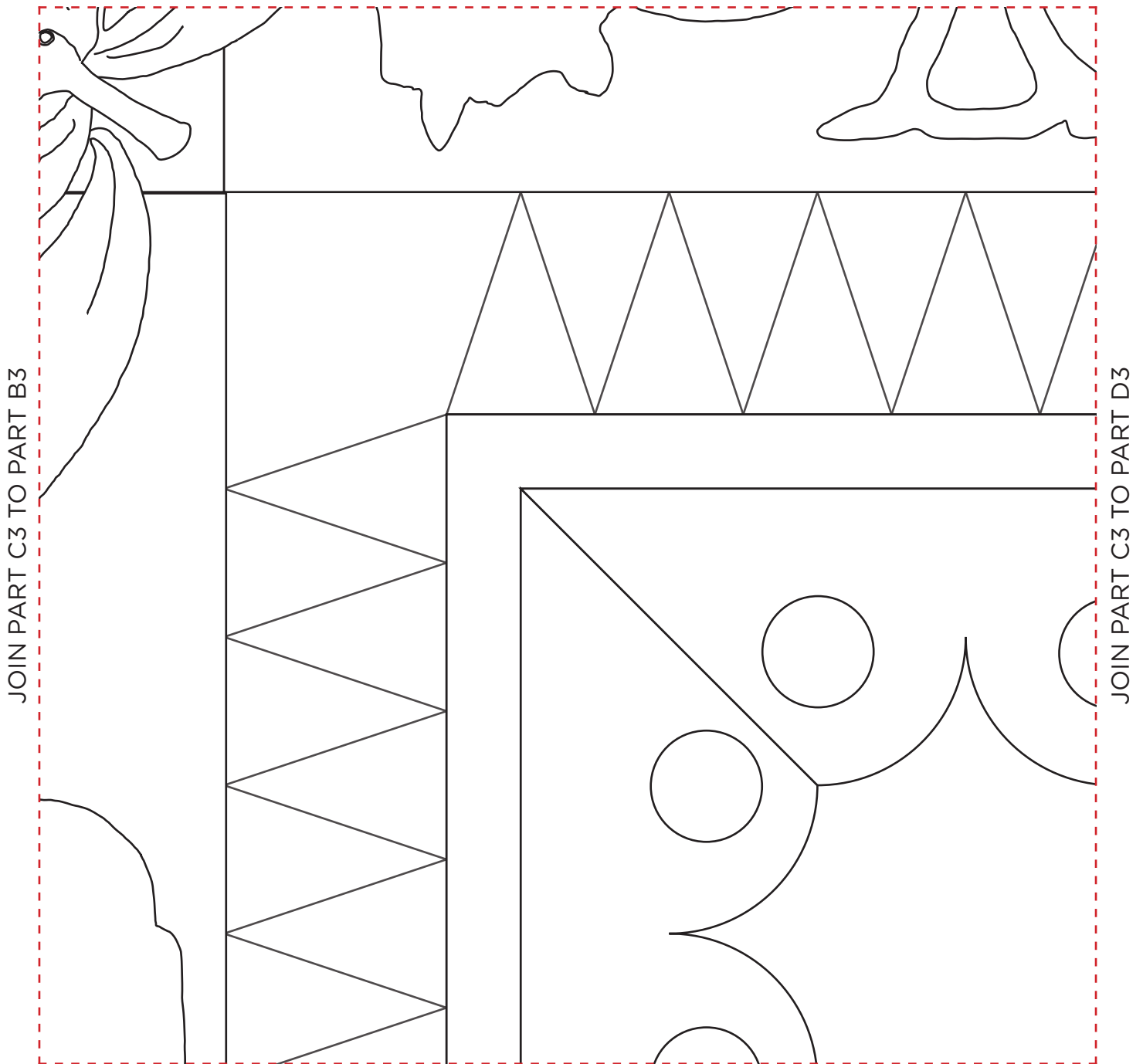

JOIN PART C3 TO PART C4

When printed
at the correct
size, this box
will measure
1in / 26mm
square

BEA'S GARDEN

Anne Varley page 26

APPLIQUÉ TEMPLATES AND LAYOUT



ACTUAL SIZE

PLEASE NOTE: Templates DO NOT include seam allowances.

PART D3

JOIN PART D3 TO PART D2

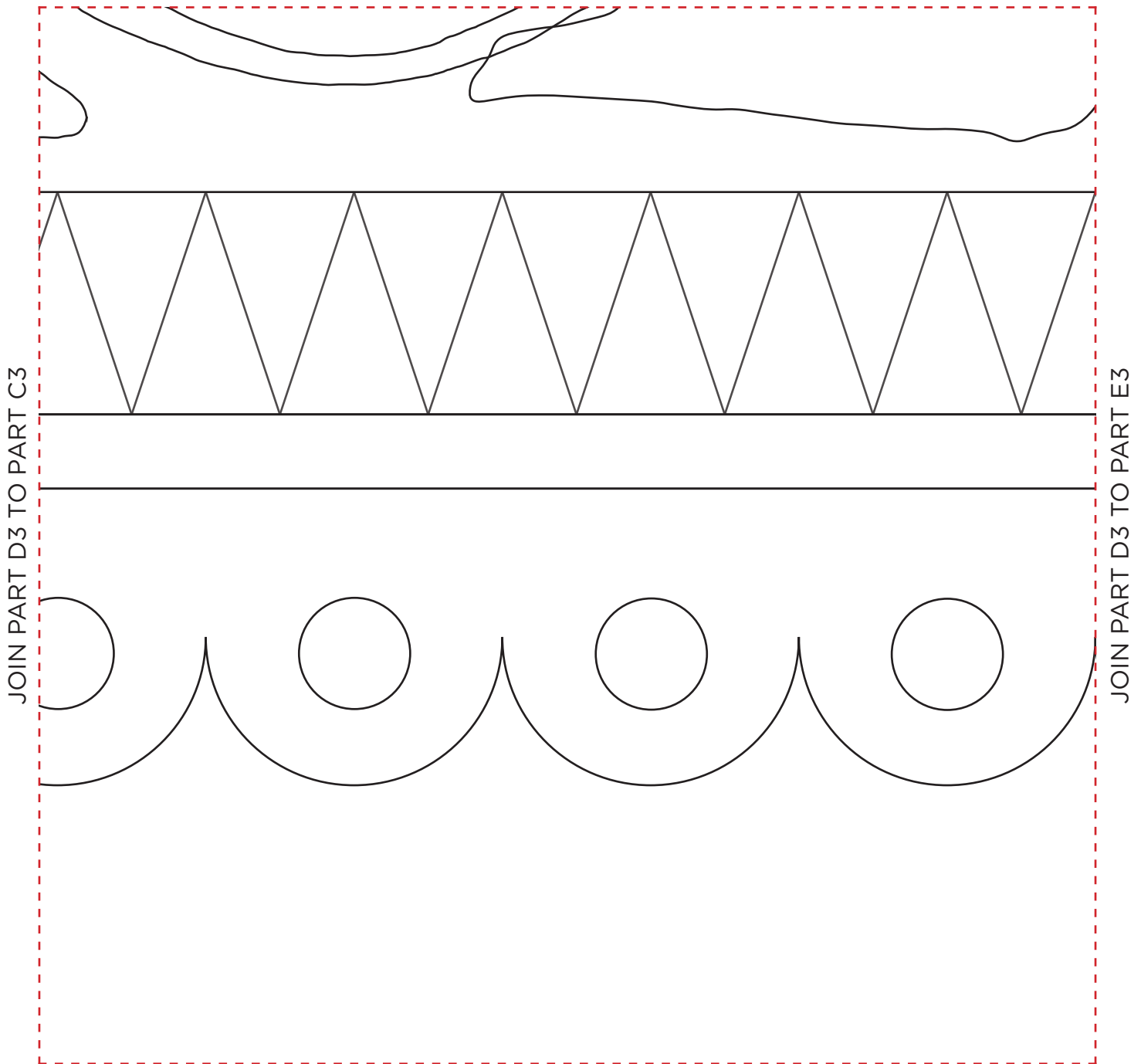

JOIN PART D3 TO PART D4

When printed
at the correct
size, this box
will measure
1in / 26mm
square

BEA'S GARDEN

Anne Varley page 26

APPLIQUÉ TEMPLATES AND LAYOUT



ACTUAL SIZE

PLEASE NOTE: Templates DO NOT include seam allowances.

PART E3

JOIN PART E3 TO PART E2

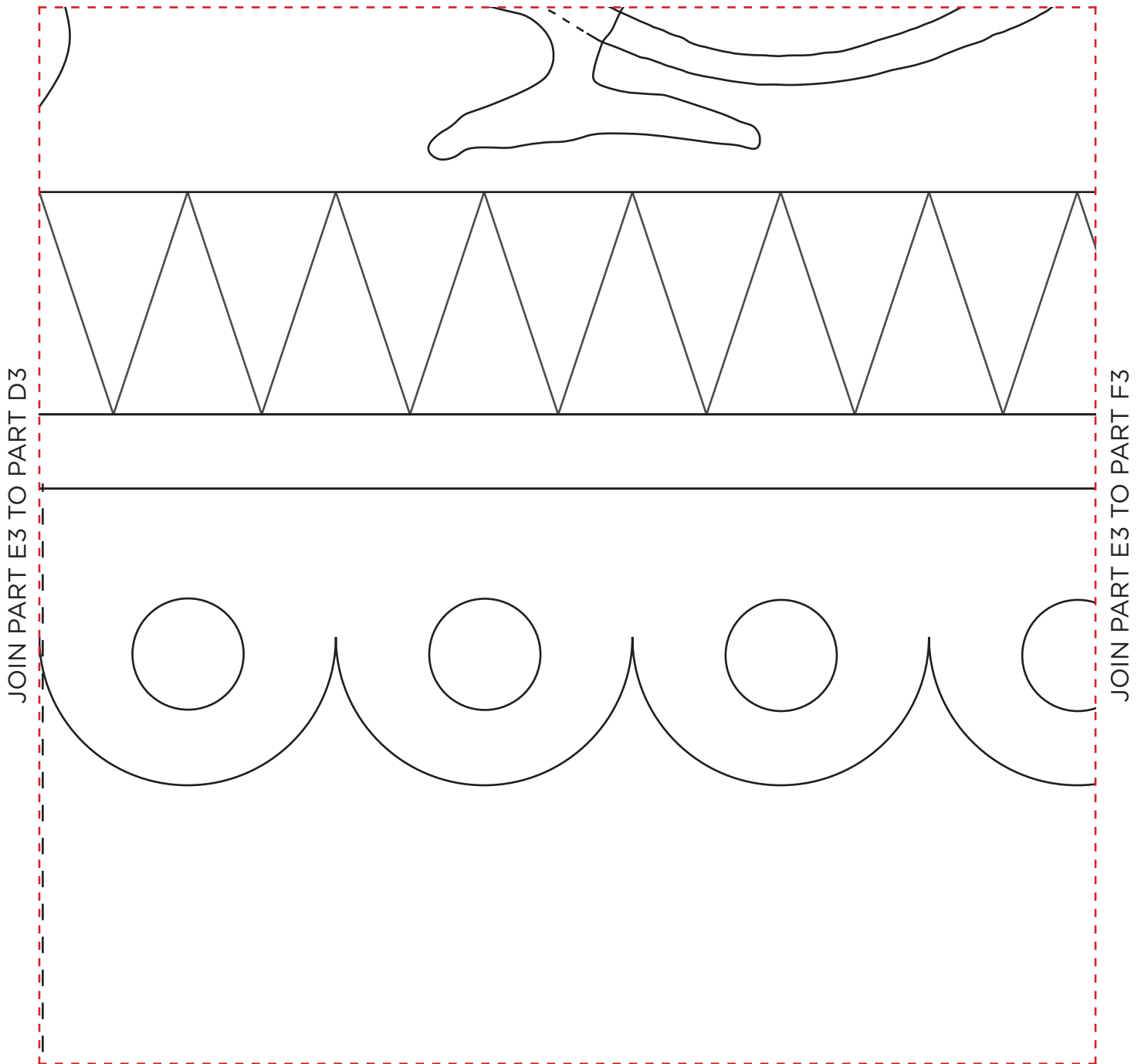

JOIN PART E3 TO PART E4

When printed
at the correct
size, this box
will measure
1in / 26mm
square

BEA'S GARDEN

Anne Varley page 26

APPLIQUÉ TEMPLATES AND LAYOUT



ACTUAL SIZE

PLEASE NOTE: Templates DO NOT include seam allowances.

PART F3

JOIN PART F3 TO PART F2

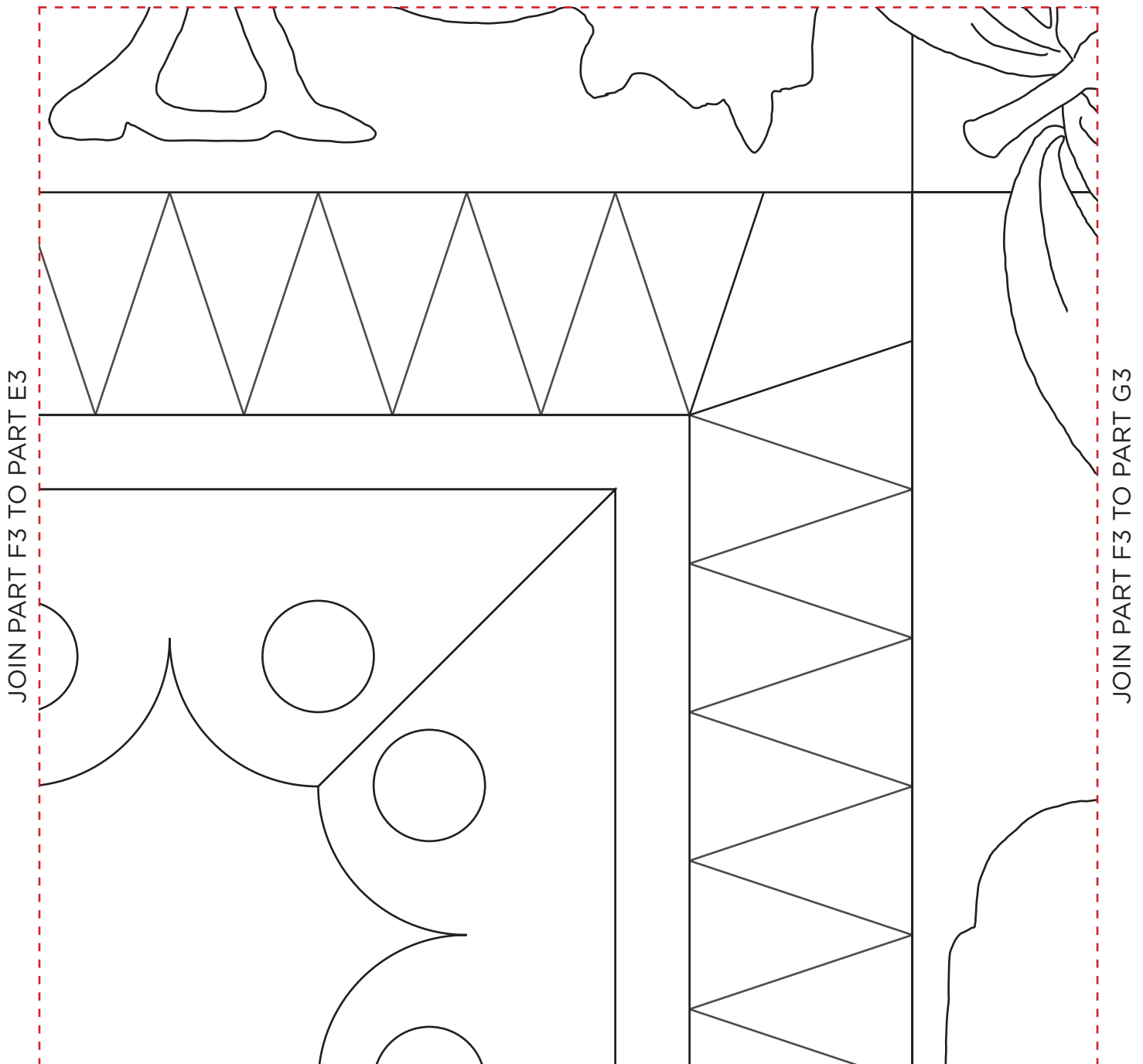

JOIN PART F3 TO PART F4

Thank you for making this project from Today's Quilter. The copyright for these templates belongs to the designer of the project. Please don't re-sell or distribute their work without permission. Please do not make any part of the templates or instructions available to others through your website or a third party website, or copy it multiple times without our permission. Copyright law protects creative work and unauthorised copying is illegal. We appreciate your help.

When printed
at the correct
size, this box
will measure
1in / 26mm
square

BEA'S GARDEN

Anne Varley page 26

APPLIQUÉ TEMPLATES AND LAYOUT



ACTUAL SIZE

PLEASE NOTE: Templates DO NOT include seam allowances.

PART G3

JOIN PART G3 TO PART G2

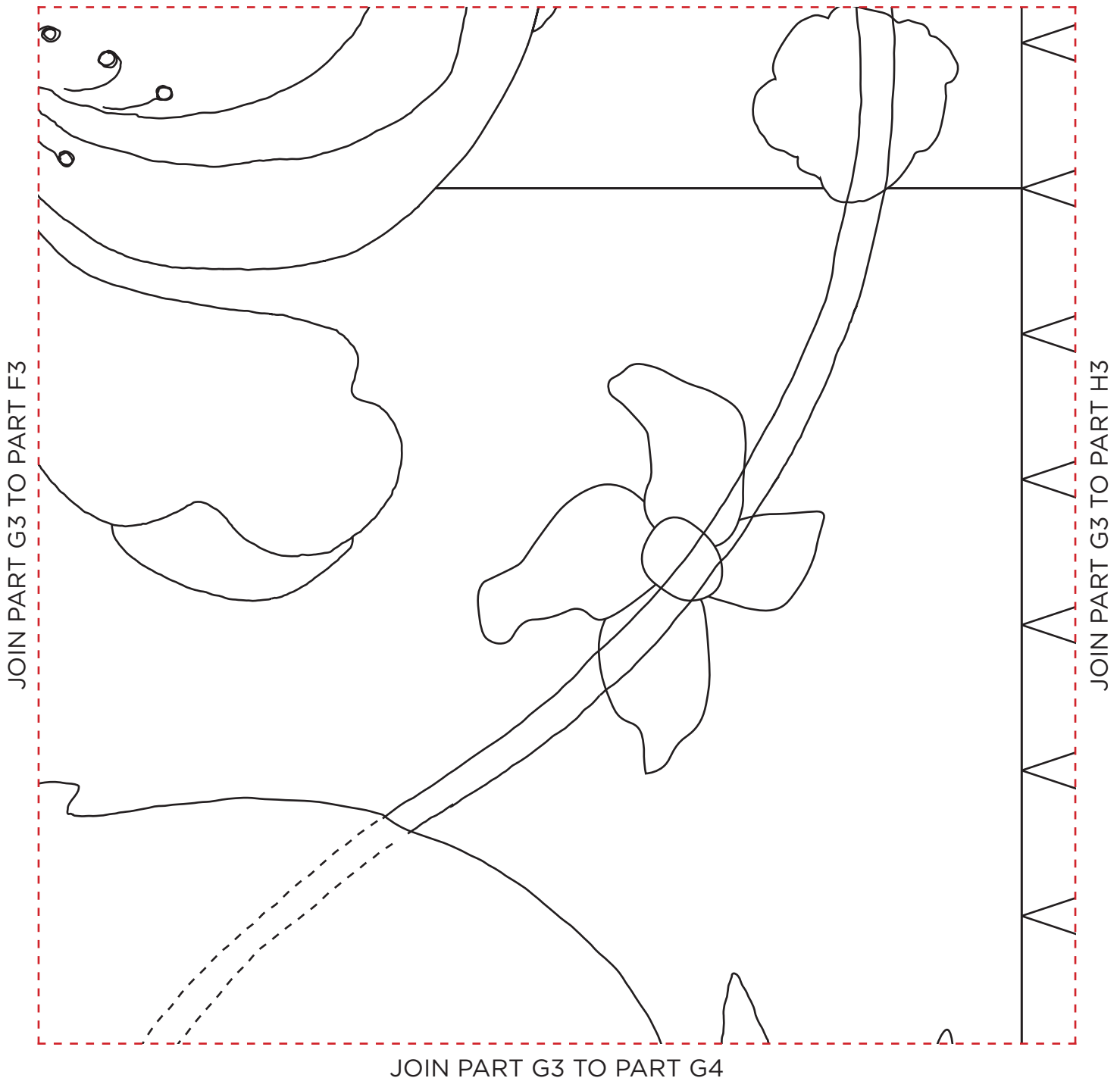

Thank you for making this project from Today's Quilter. The copyright for these templates belongs to the designer of the project. Please don't re-sell or distribute their work without permission. Please do not make any part of the templates or instructions available to others through your website or a third party website, or copy it multiple times without our permission. Copyright law protects creative work and unauthorised copying is illegal. We appreciate your help.

When printed
at the correct
size, this box
will measure
1in / 26mm
square

BEA'S GARDEN

Anne Varley page 26

APPLIQUÉ TEMPLATES AND LAYOUT



ACTUAL SIZE

PLEASE NOTE: Templates DO NOT include seam allowances.

PART H3

JOIN PART H3 TO PART H2

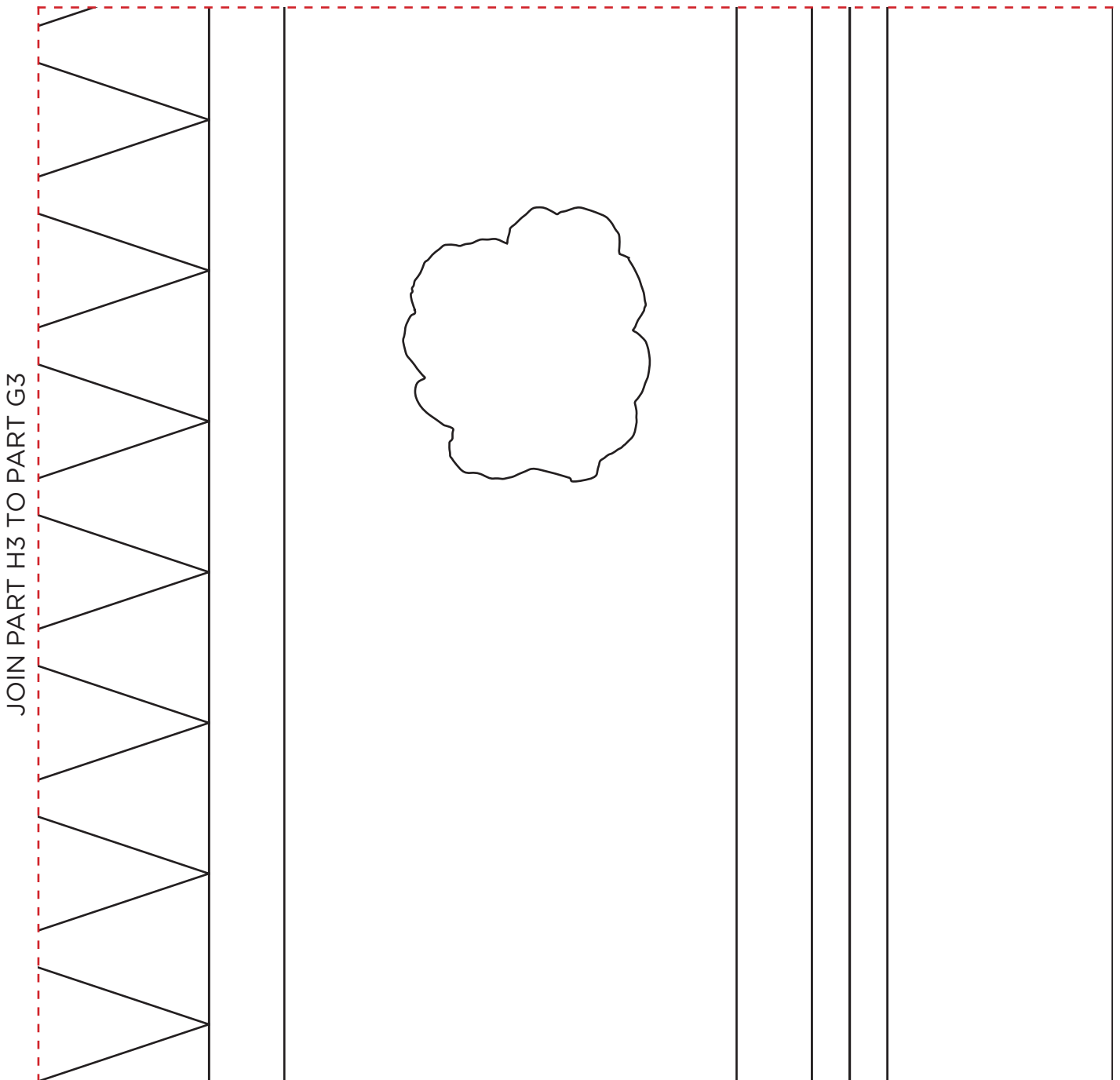

JOIN PART H3 TO PART H4

When printed
at the correct
size, this box
will measure
1in / 26mm
square

BEA'S GARDEN

Anne Varley page 26

APPLIQUÉ TEMPLATES AND LAYOUT



ACTUAL SIZE

PLEASE NOTE: Templates DO NOT include seam allowances.

PART A4

JOIN PART A4 TO PART A3

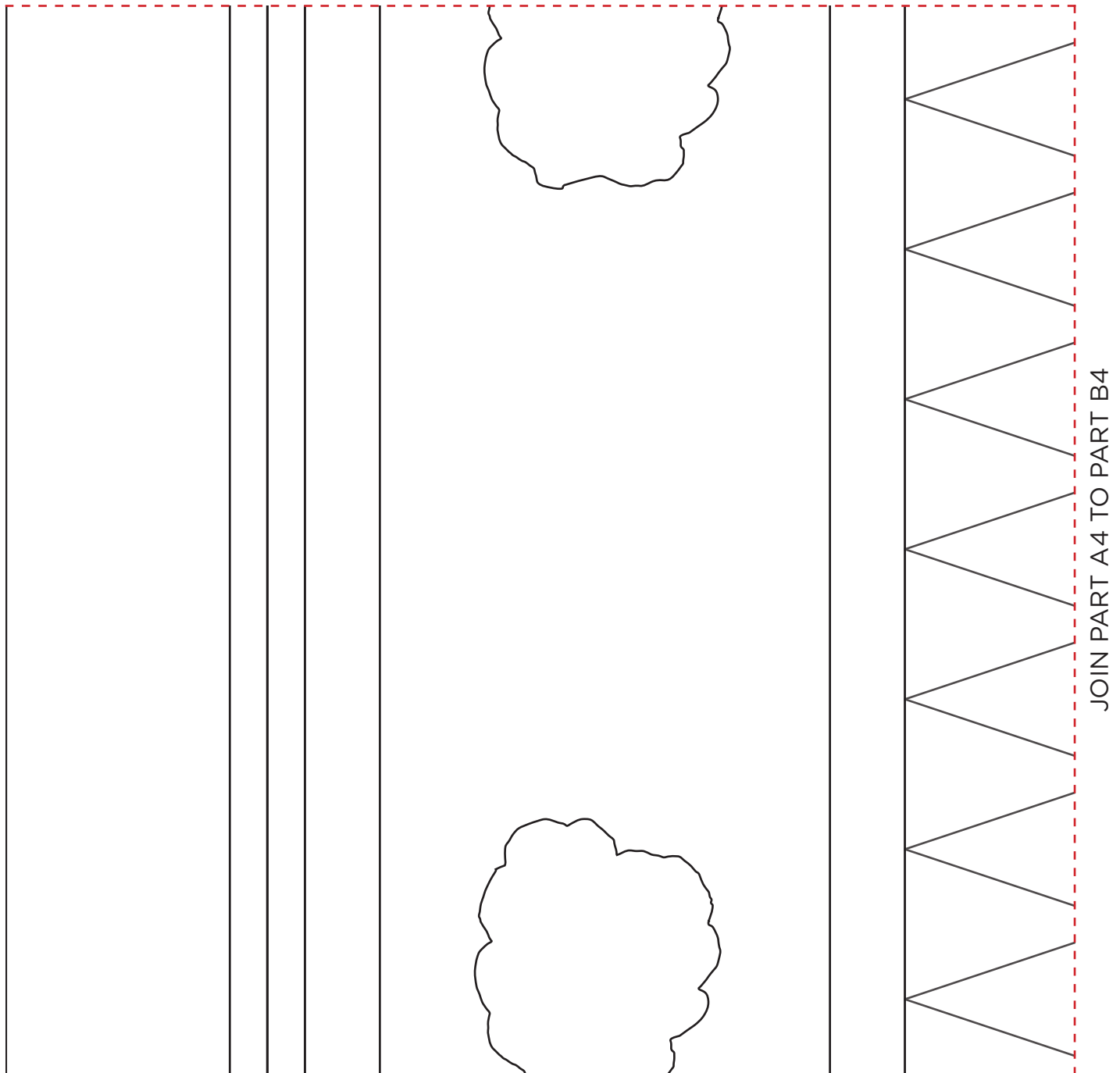

JOIN PART A4 TO PART A5

Thank you for making this project from Today's Quilter. The copyright for these templates belongs to the designer of the project. Please don't re-sell or distribute their work without permission. Please do not make any part of the templates or instructions available to others through your website or a third party website, or copy it multiple times without our permission. Copyright law protects creative work and unauthorised copying is illegal. We appreciate your help.

When printed
at the correct
size, this box
will measure
1in / 26mm
square

BEA'S GARDEN

Anne Varley page 26

APPLIQUÉ TEMPLATES AND LAYOUT



ACTUAL SIZE

PLEASE NOTE: Templates DO NOT include seam allowances.

PART B4

JOIN PART B4 TO PART B3

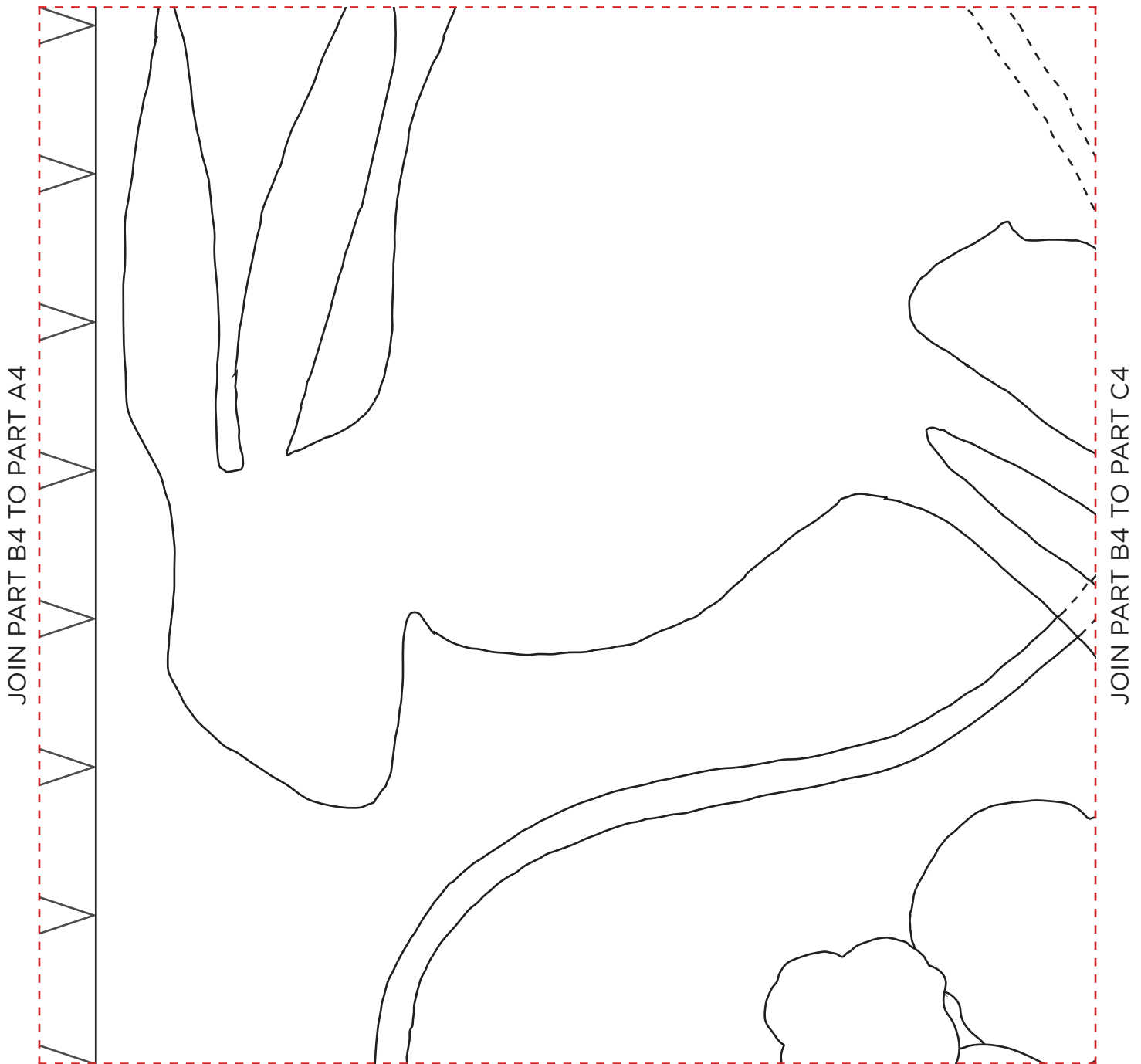

JOIN PART B4 TO PART B5

Thank you for making this project from Today's Quilter. The copyright for these templates belongs to the designer of the project. Please don't re-sell or distribute their work without permission. Please do not make any part of the templates or instructions available to others through your website or a third party website, or copy it multiple times without our permission. Copyright law protects creative work and unauthorised copying is illegal. We appreciate your help.

TODAY'S
QUILTER
Create beautiful quilts for your home

When printed
at the correct
size, this box
will measure
1in / 26mm
square

BEA'S GARDEN

Anne Varley page 26

APPLIQUÉ TEMPLATES AND LAYOUT



ACTUAL SIZE

PLEASE NOTE: Templates DO NOT include seam allowances.

PART C4

JOIN PART C4 TO PART C3

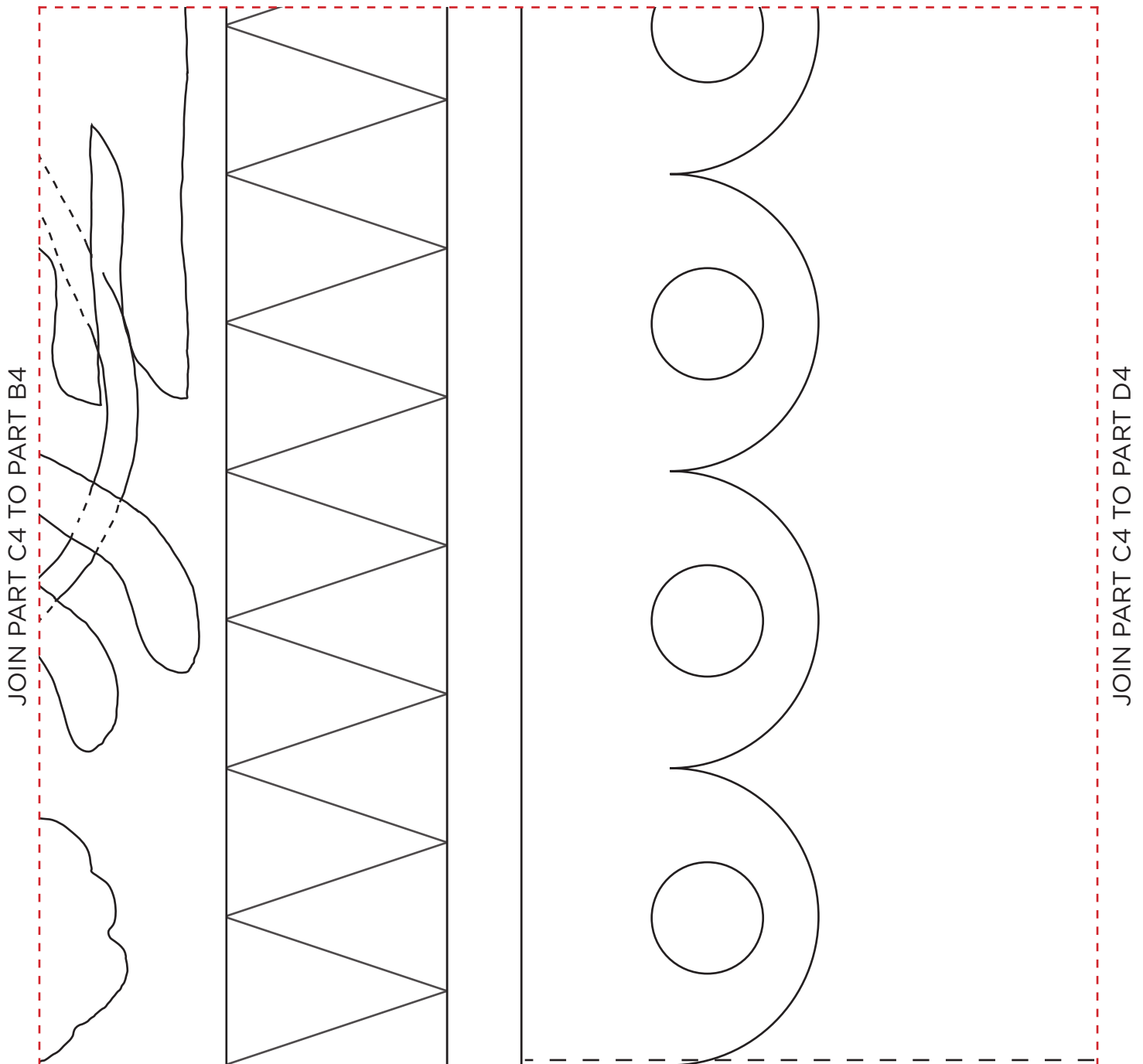

JOIN PART C4 TO PART C5

Thank you for making this project from Today's Quilter. The copyright for these templates belongs to the designer of the project. Please don't re-sell or distribute their work without permission. Please do not make any part of the templates or instructions available to others through your website or a third party website, or copy it multiple times without our permission. Copyright law protects creative work and unauthorised copying is illegal. We appreciate your help.

When printed
at the correct
size, this box
will measure
1in / 26mm
square

BEA'S GARDEN

Anne Varley page 26

APPLIQUÉ TEMPLATES AND LAYOUT



ACTUAL SIZE

PLEASE NOTE: Templates DO NOT include seam allowances.

PART D4

JOIN PART D4 TO PART D3

JOIN PART D4 TO PART C4

JOIN PART D4 TO PART E4

JOIN PART D4 TO PART D5

When printed
at the correct
size, this box
will measure
1in / 26mm
square

BEA'S GARDEN

Anne Varley page 26

APPLIQUÉ TEMPLATES AND LAYOUT



ACTUAL SIZE

PLEASE NOTE: Templates DO NOT include seam allowances.

PART E4

JOIN PART E4 TO PART E3

JOIN PART E4 TO PART D4

JOIN PART E4 TO PART F4

JOIN PART E4 TO PART E5

Thank you for making this project from Today's Quilter. The copyright for these templates belongs to the designer of the project. Please don't re-sell or distribute their work without permission. Please do not make any part of the templates or instructions available to others through your website or a third party website, or copy it multiple times without our permission. Copyright law protects creative work and unauthorised copying is illegal. We appreciate your help.

TODAY'S
QUILTER
Create beautiful quilts for your home

When printed at the correct size, this box will measure 1in / 26mm square

BEA'S GARDEN

Anne Varley page 26

APPLIQUÉ TEMPLATES AND LAYOUT



ACTUAL SIZE

PLEASE NOTE: Templates DO NOT include seam allowances.

PART F4

JOIN PART F4 TO PART F3

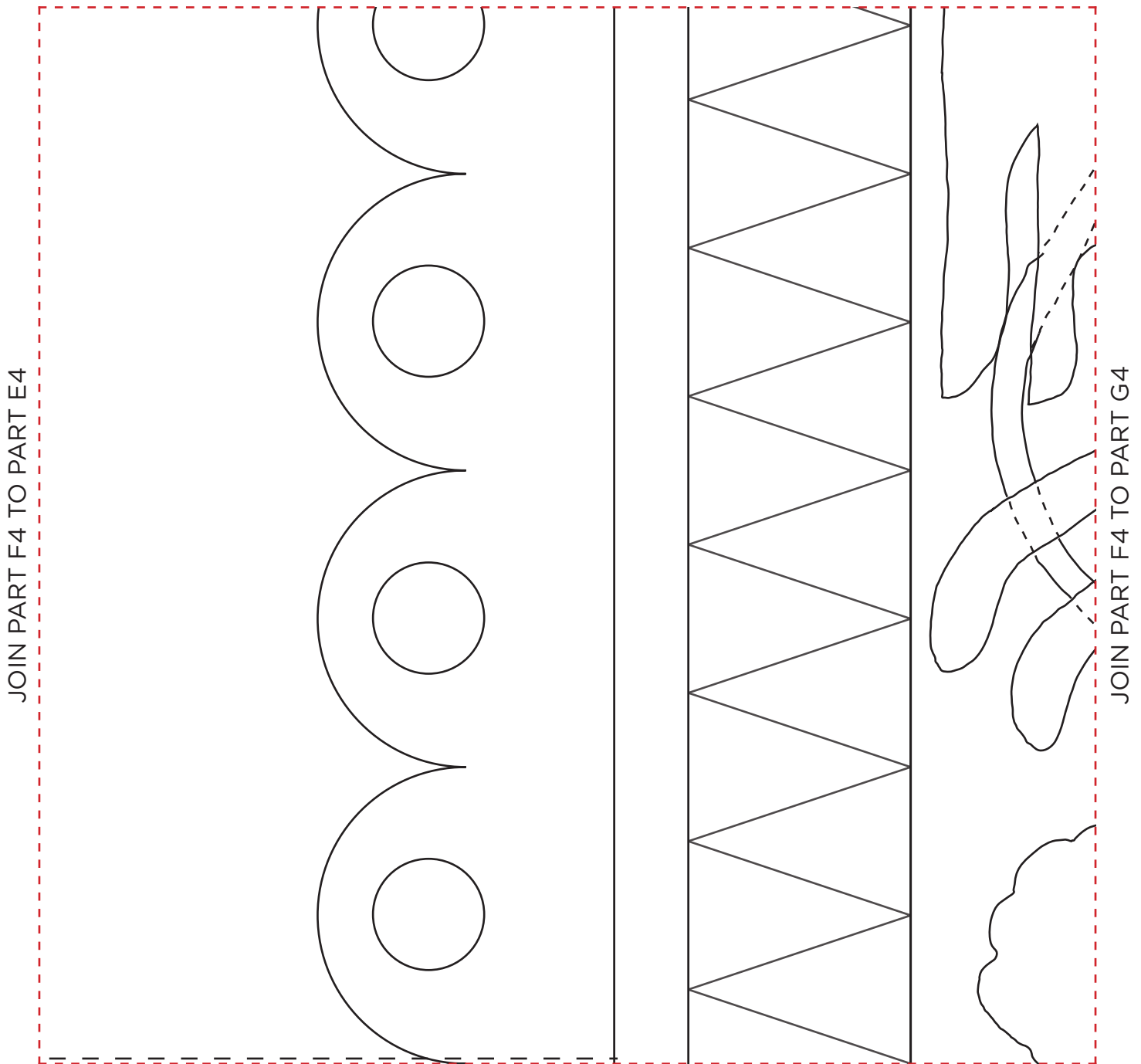

JOIN PART F4 TO PART F5

Thank you for making this project from Today's Quilter. The copyright for these templates belongs to the designer of the project. Please don't re-sell or distribute their work without permission. Please do not make any part of the templates or instructions available to others through your website or a third party website, or copy it multiple times without our permission. Copyright law protects creative work and unauthorised copying is illegal. We appreciate your help.

When printed
at the correct
size, this box
will measure
1in / 26mm
square

BEA'S GARDEN

Anne Varley page 26

APPLIQUÉ TEMPLATES AND LAYOUT



ACTUAL SIZE

PLEASE NOTE: Templates DO NOT include seam allowances.

PART G4

JOIN PART G4 TO PART G3

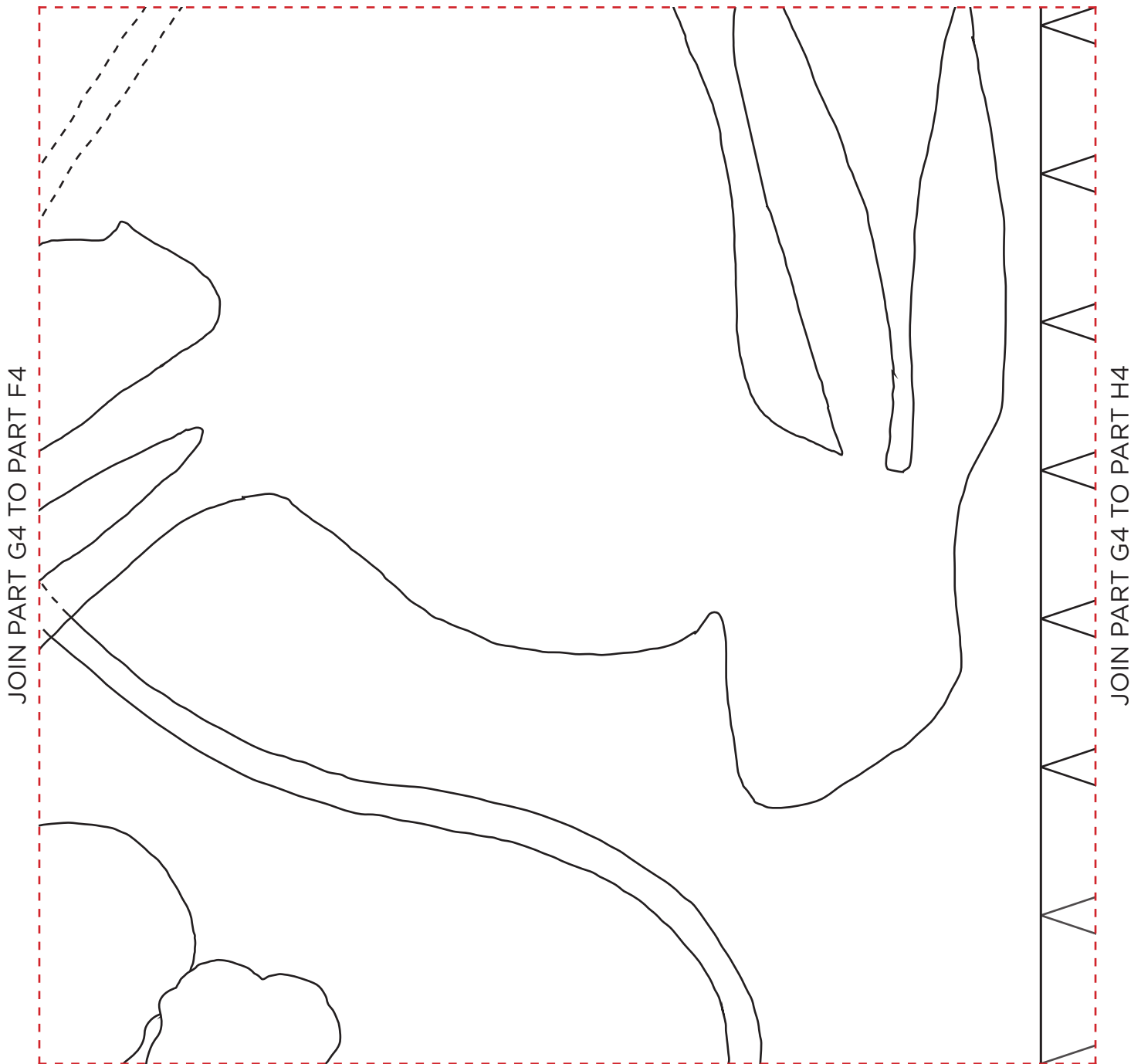

JOIN PART G4 TO PART G5

Thank you for making this project from Today's Quilter. The copyright for these templates belongs to the designer of the project. Please don't re-sell or distribute their work without permission. Please do not make any part of the templates or instructions available to others through your website or a third party website, or copy it multiple times without our permission. Copyright law protects creative work and unauthorised copying is illegal. We appreciate your help.

TODAY'S
QUILTER
Create beautiful quilts for your home

When printed
at the correct
size, this box
will measure
1in / 26mm
square

BEA'S GARDEN

Anne Varley page 26

APPLIQUÉ TEMPLATES AND LAYOUT



ACTUAL SIZE

PLEASE NOTE: Templates DO NOT include seam allowances.

PART H4

JOIN PART H4 TO PART H3

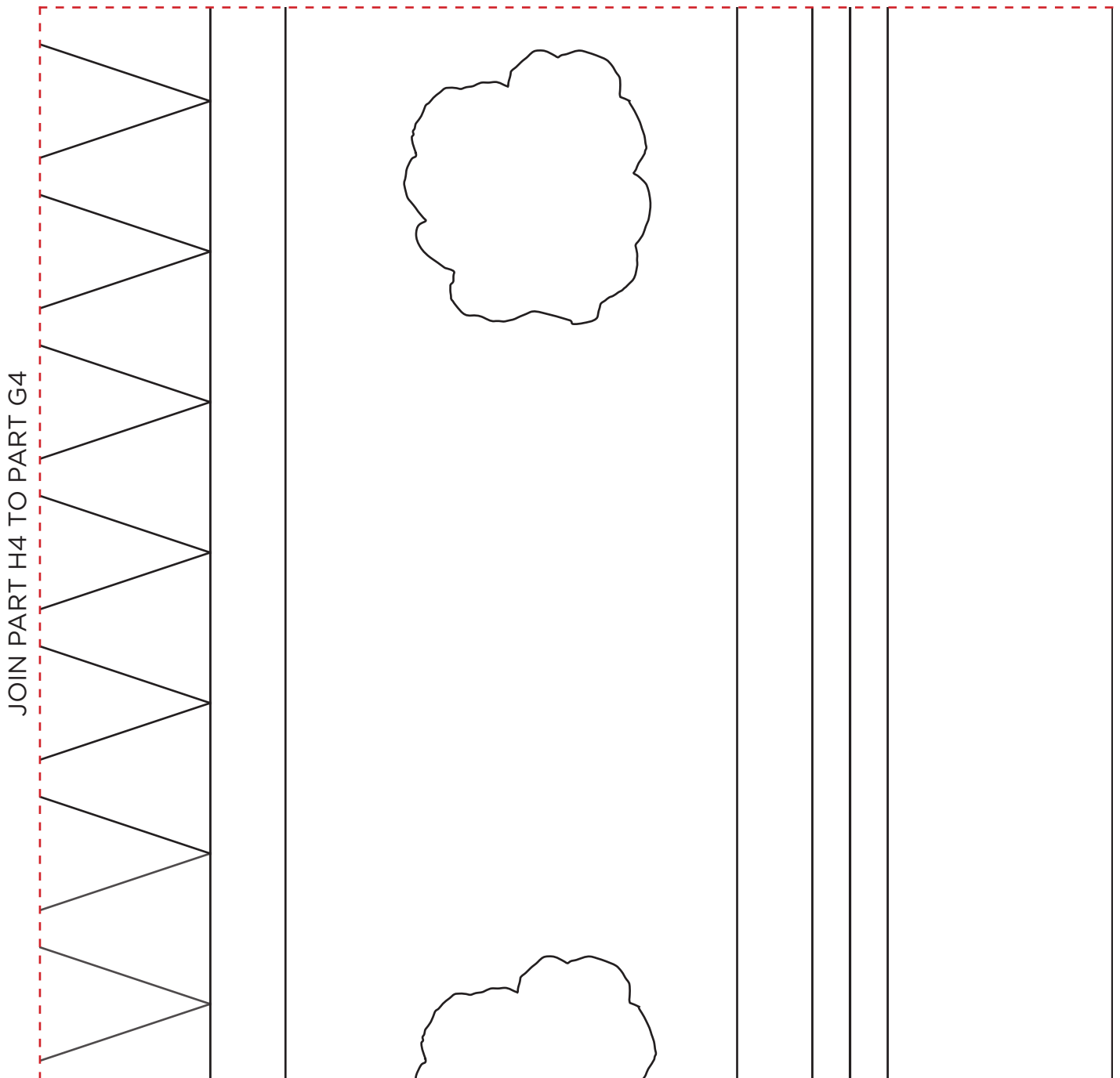

JOIN PART H4 TO PART H5

When printed
at the correct
size, this box
will measure
1in / 26mm
square

BEA'S GARDEN

Anne Varley page 26

APPLIQUÉ TEMPLATES AND LAYOUT



ACTUAL SIZE

PLEASE NOTE: Templates DO NOT include seam allowances.

PART A5

JOIN PART A5 TO PART A4

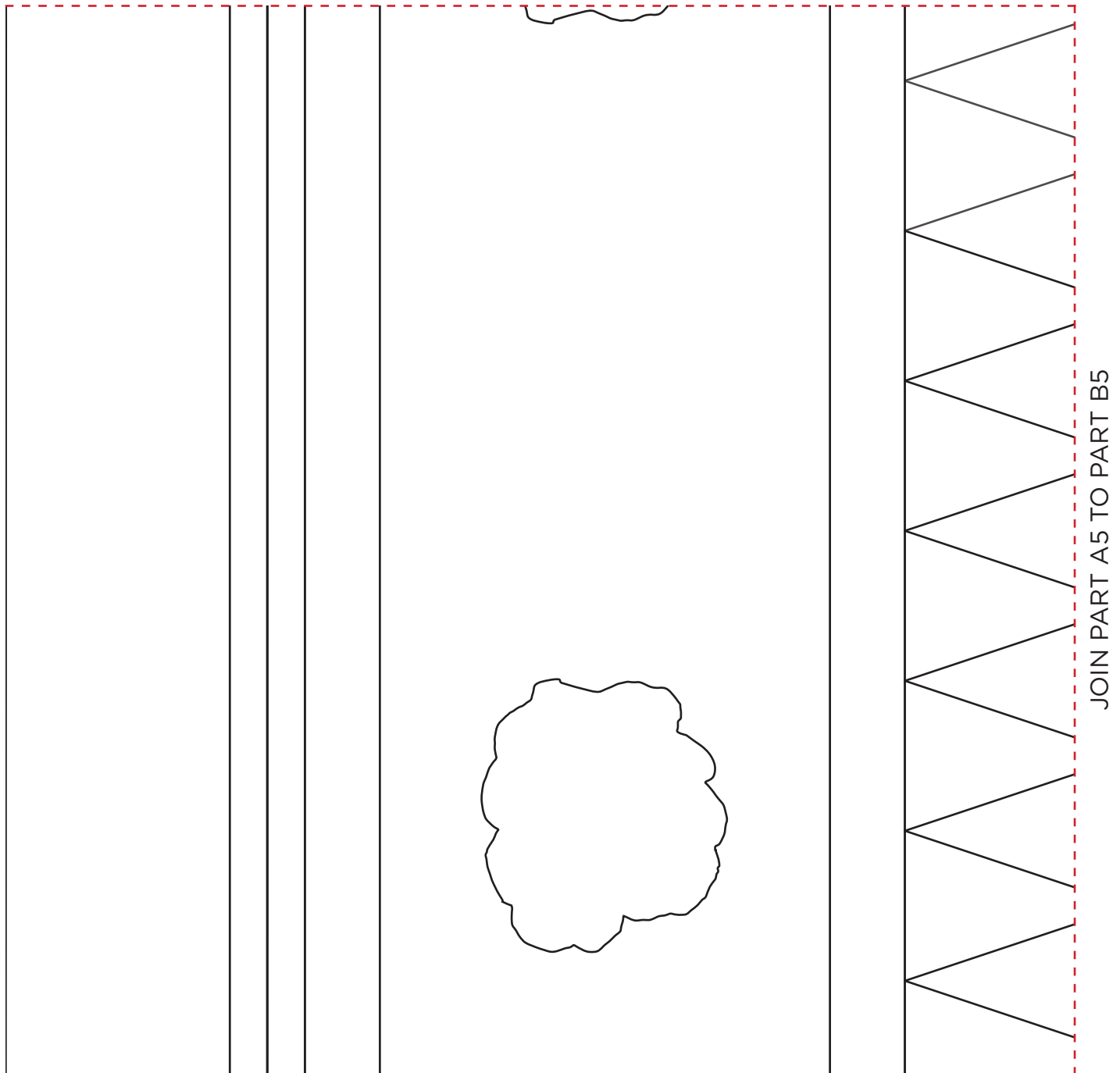

JOIN PART A5 TO PART A6

When printed
at the correct
size, this box
will measure
1in / 26mm
square

BEA'S GARDEN

Anne Varley page 26

APPLIQUÉ TEMPLATES AND LAYOUT



ACTUAL SIZE

PLEASE NOTE: Templates DO NOT include seam allowances.

PART B5

JOIN PART B5 TO PART B4

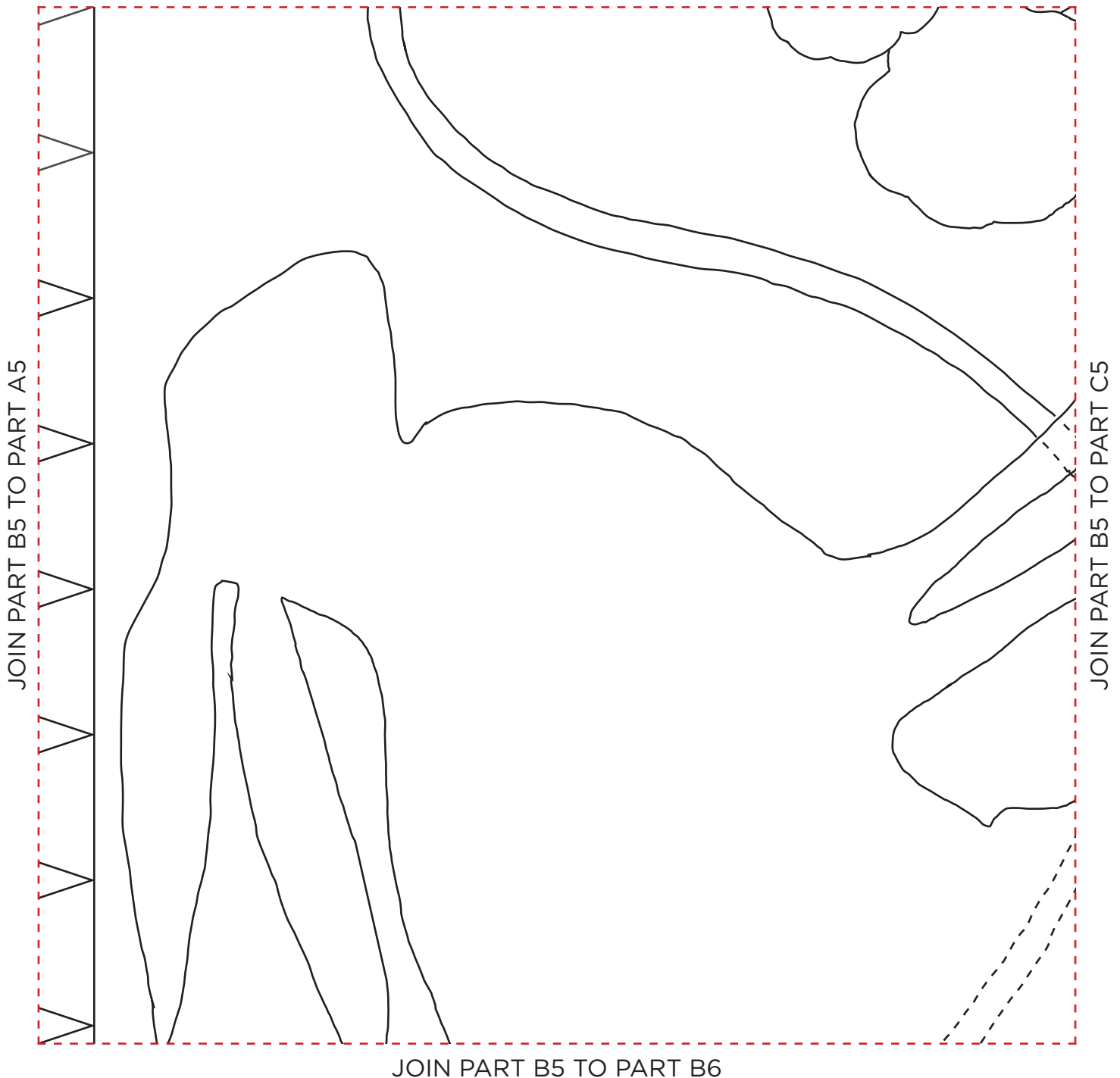

Thank you for making this project from Today's Quilter. The copyright for these templates belongs to the designer of the project. Please don't re-sell or distribute their work without permission. Please do not make any part of the templates or instructions available to others through your website or a third party website, or copy it multiple times without our permission. Copyright law protects creative work and unauthorised copying is illegal. We appreciate your help.

When printed
at the correct
size, this box
will measure
1in / 26mm
square

BEA'S GARDEN

Anne Varley page 26

APPLIQUÉ TEMPLATES AND LAYOUT



ACTUAL SIZE

PLEASE NOTE: Templates DO NOT include seam allowances.

PART C5

JOIN PART C5 TO PART C4

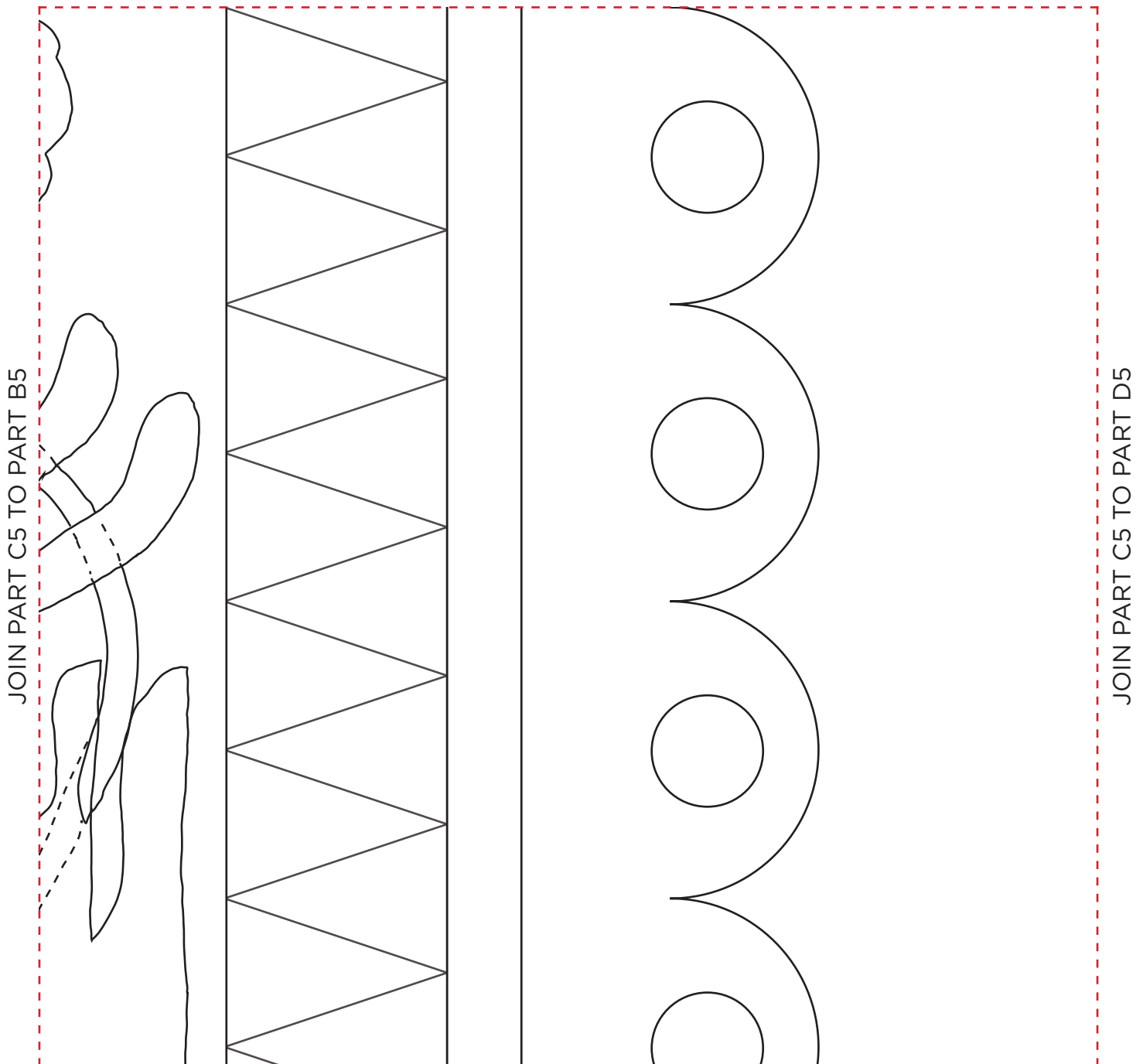

JOIN PART C5 TO PART C6

When printed
at the correct
size, this box
will measure
1in / 26mm
square

BEA'S GARDEN

Anne Varley page 26

APPLIQUÉ TEMPLATES AND LAYOUT



ACTUAL SIZE

PLEASE NOTE: Templates DO NOT include seam allowances.

PART D5

JOIN PART D5 TO PART D4

JOIN PART D5 TO PART C5

JOIN PART D5 TO PART E5

JOIN PART D5 TO PART D6

When printed
at the correct
size, this box
will measure
1in / 26mm
square

BEA'S GARDEN

Anne Varley page 26

APPLIQUÉ TEMPLATES AND LAYOUT



ACTUAL SIZE

PLEASE NOTE: Templates DO NOT include seam allowances.

PART E5

JOIN PART E5 TO PART E4

JOIN PART E5 TO PART D5

JOIN PART E5 TO PART F5

JOIN PART E5 TO PART E6

When printed
at the correct
size, this box
will measure
1in / 26mm
square

BEA'S GARDEN

Anne Varley page 26

APPLIQUÉ TEMPLATES AND LAYOUT



ACTUAL SIZE

PLEASE NOTE: Templates DO NOT include seam allowances.

PART F5

JOIN PART F5 TO PART F4

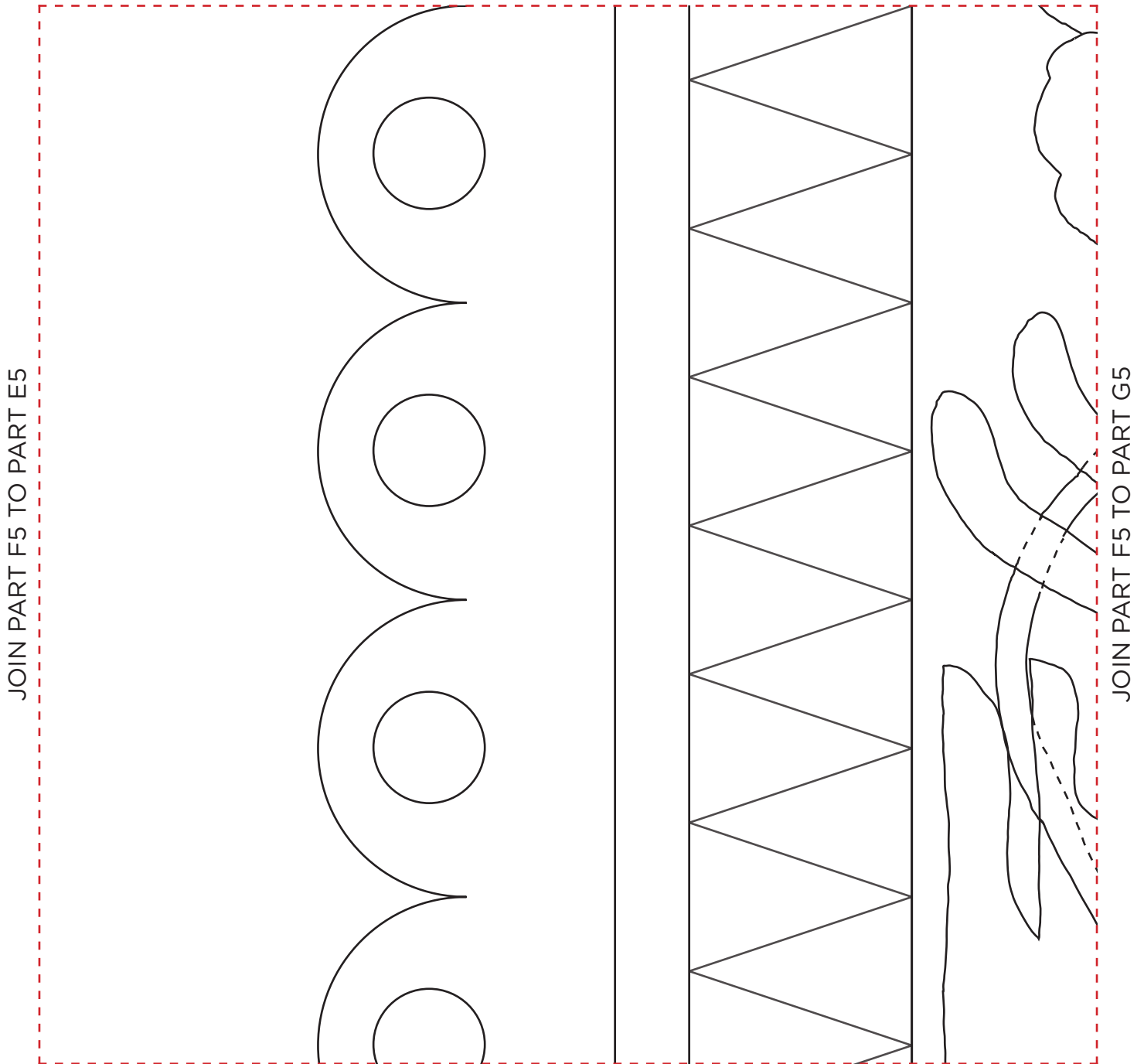

JOIN PART F5 TO PART F6

When printed
at the correct
size, this box
will measure
1in / 26mm
square

BEA'S GARDEN

Anne Varley page 26

APPLIQUÉ TEMPLATES AND LAYOUT



ACTUAL SIZE

PLEASE NOTE: Templates DO NOT include seam allowances.

PART G5

JOIN PART G5 TO PART G4

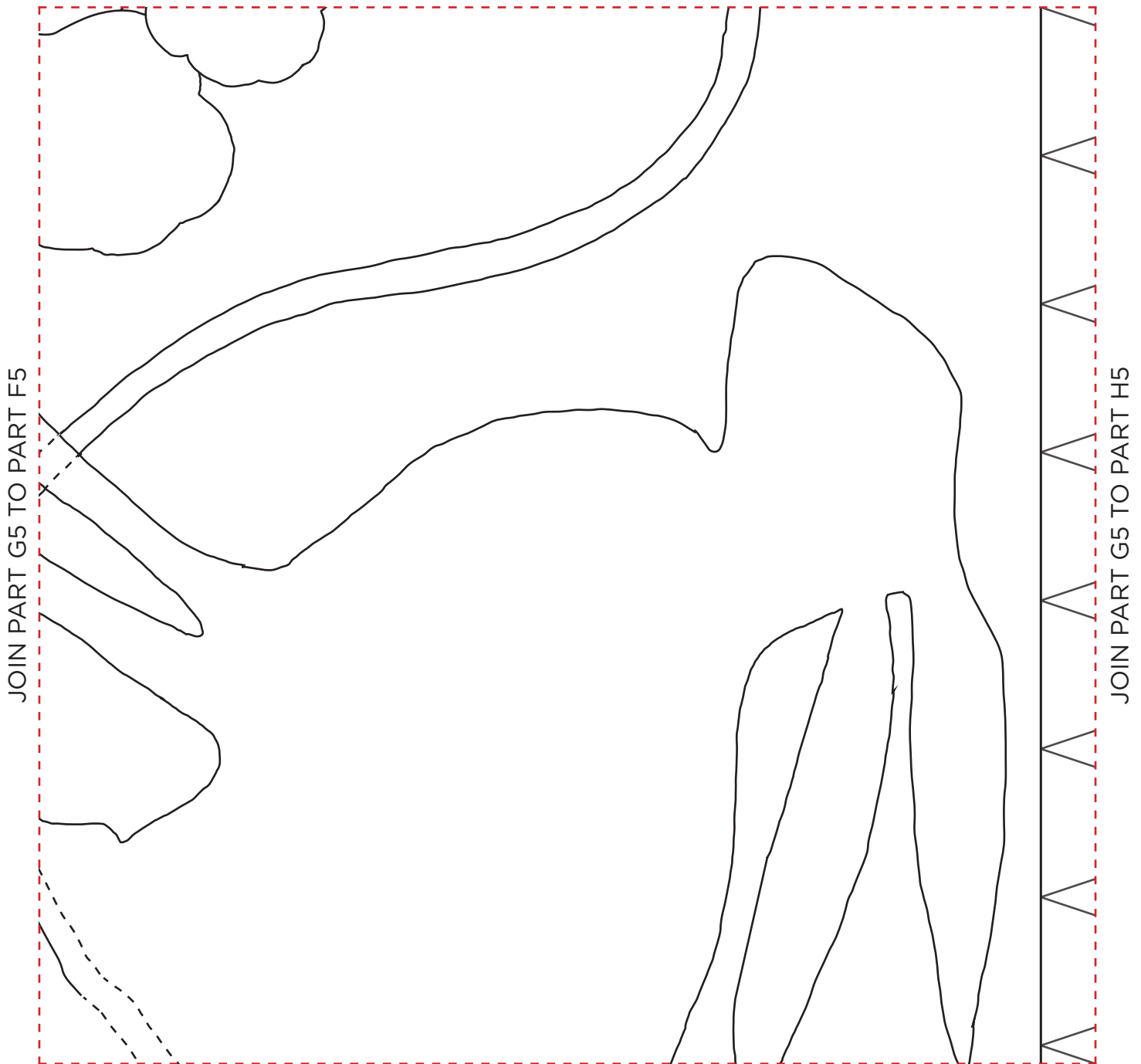

JOIN PART G5 TO PART G6

Thank you for making this project from Today's Quilter. The copyright for these templates belongs to the designer of the project. Please don't re-sell or distribute their work without permission. Please do not make any part of the templates or instructions available to others through your website or a third party website, or copy it multiple times without our permission. Copyright law protects creative work and unauthorised copying is illegal. We appreciate your help.

When printed
at the correct
size, this box
will measure
1in / 26mm
square

BEA'S GARDEN

Anne Varley page 26

APPLIQUÉ TEMPLATES AND LAYOUT



ACTUAL SIZE

PLEASE NOTE: Templates DO NOT include seam allowances.

PART H5

JOIN PART H5 TO PART H4

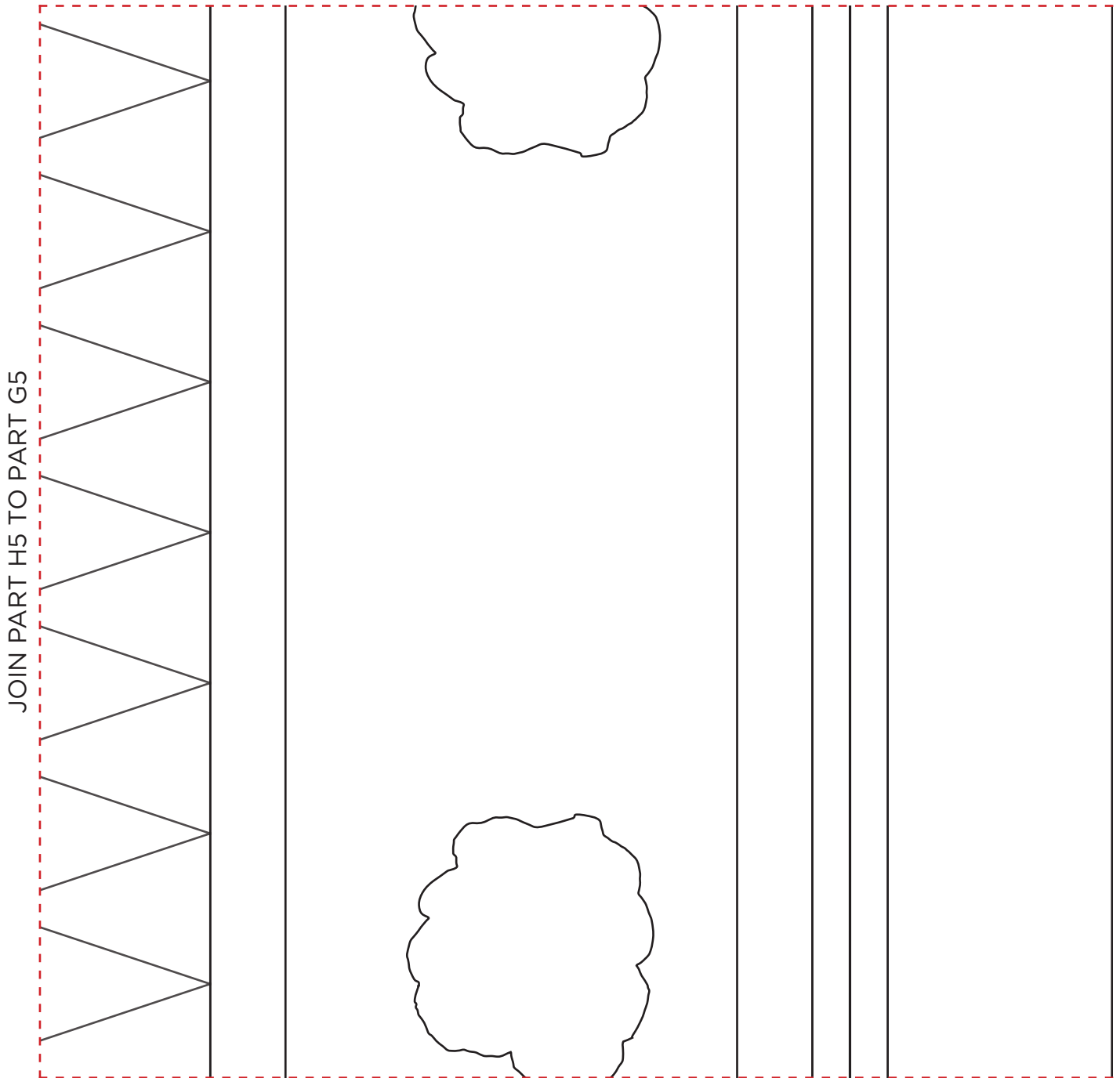

JOIN PART H5 TO PART H6

When printed
at the correct
size, this box
will measure
1in / 26mm
square

BEA'S GARDEN

Anne Varley page 26

APPLIQUÉ TEMPLATES AND LAYOUT



ACTUAL SIZE

PLEASE NOTE: Templates DO NOT include seam allowances.

PART A6

JOIN PART A6 TO PART A5

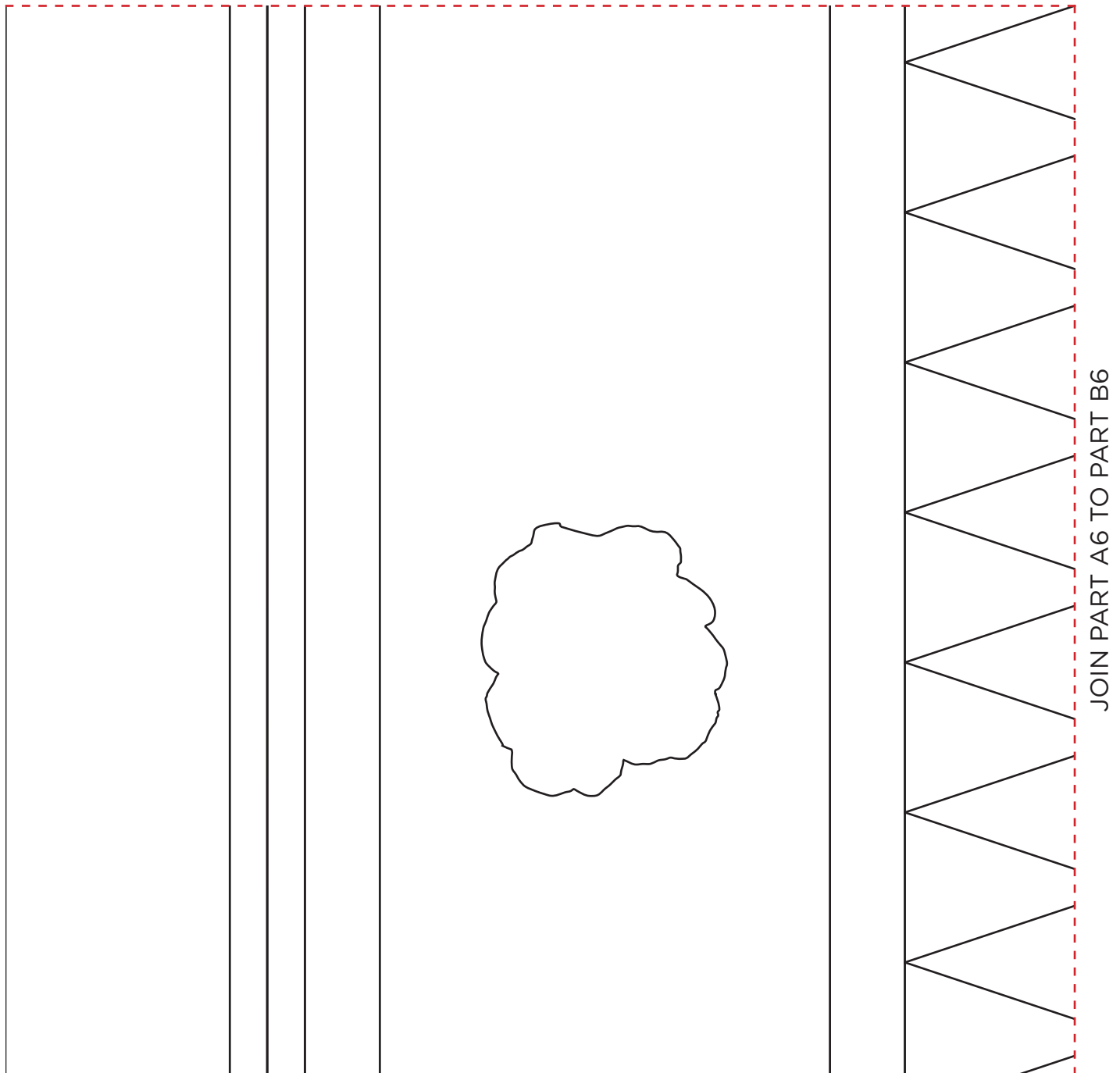

JOIN PART A6 TO PART A7

When printed
at the correct
size, this box
will measure
1in / 26mm
square

BEA'S GARDEN

Anne Varley page 26

APPLIQUÉ TEMPLATES AND LAYOUT



ACTUAL SIZE

PLEASE NOTE: Templates DO NOT include seam allowances.

PART B6

JOIN PART B6 TO PART B5



When printed
at the correct
size, this box
will measure
1in / 26mm
square

BEA'S GARDEN

Anne Varley page 26

APPLIQUÉ TEMPLATES AND LAYOUT



ACTUAL SIZE

PLEASE NOTE: Templates DO NOT include seam allowances.

PART C6

JOIN PART C6 TO PART C5

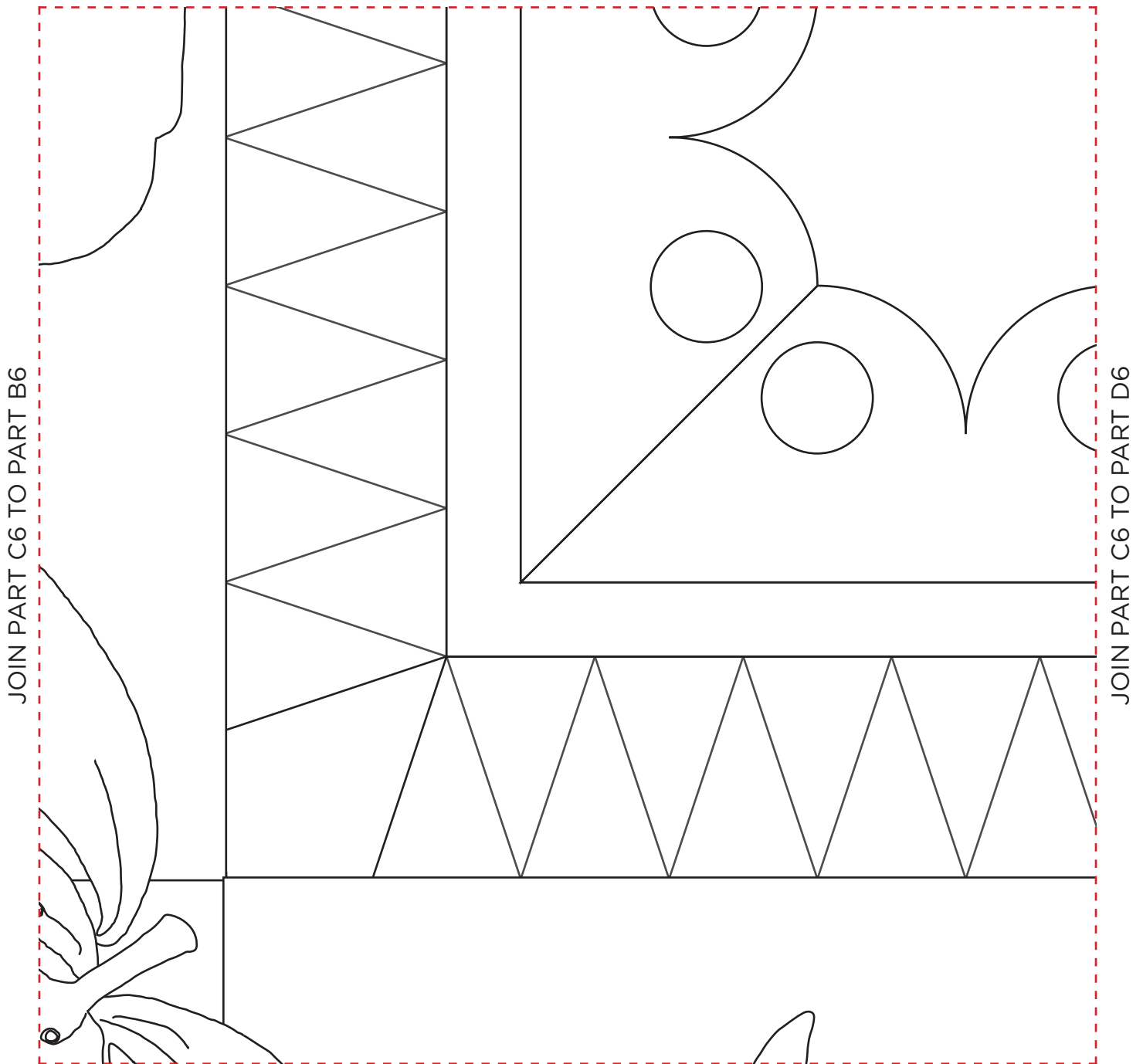

JOIN PART C6 TO PART C7

When printed
at the correct
size, this box
will measure
1in / 26mm
square

BEA'S GARDEN

Anne Varley page 26

APPLIQUÉ TEMPLATES AND LAYOUT



ACTUAL SIZE

PLEASE NOTE: Templates DO NOT include seam allowances.

PART D6

JOIN PART D6 TO PART D5

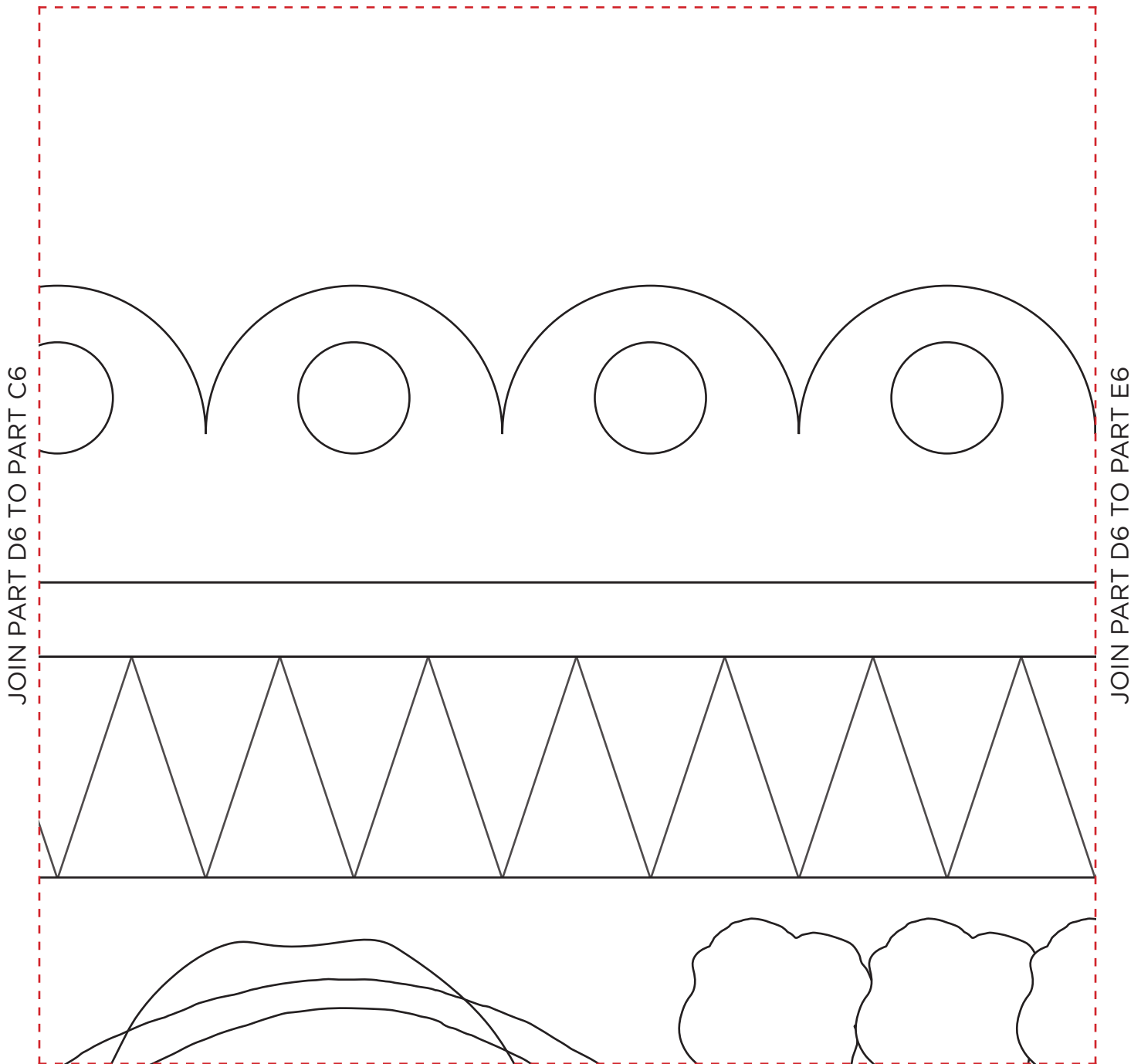

JOIN PART D6 TO PART D7

Thank you for making this project from Today's Quilter. The copyright for these templates belongs to the designer of the project. Please don't re-sell or distribute their work without permission. Please do not make any part of the templates or instructions available to others through your website or a third party website, or copy it multiple times without our permission. Copyright law protects creative work and unauthorised copying is illegal. We appreciate your help.

When printed
at the correct
size, this box
will measure
1in / 26mm
square

BEA'S GARDEN

Anne Varley page 26

APPLIQUÉ TEMPLATES AND LAYOUT



ACTUAL SIZE

PLEASE NOTE: Templates DO NOT include seam allowances.

PART E6

JOIN PART E6 TO PART E5

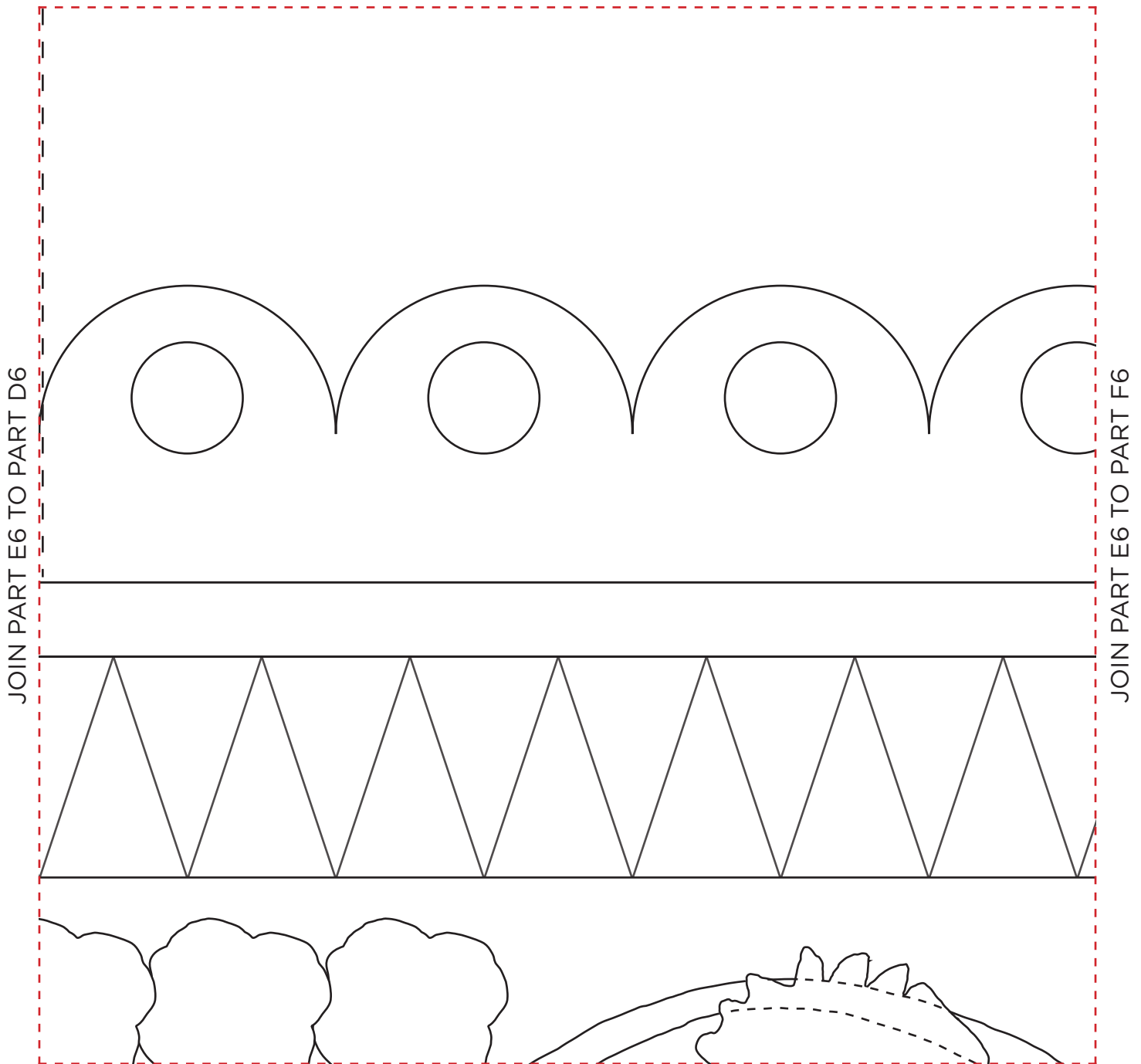

JOIN PART E6 TO PART E7

Thank you for making this project from Today's Quilter. The copyright for these templates belongs to the designer of the project. Please don't re-sell or distribute their work without permission. Please do not make any part of the templates or instructions available to others through your website or a third party website, or copy it multiple times without our permission. Copyright law protects creative work and unauthorised copying is illegal. We appreciate your help.

When printed
at the correct
size, this box
will measure
1in / 26mm
square

BEA'S GARDEN

Anne Varley page 26

APPLIQUÉ TEMPLATES AND LAYOUT



ACTUAL SIZE

PLEASE NOTE: Templates DO NOT include seam allowances.

PART F6

JOIN PART F6 TO PART F5

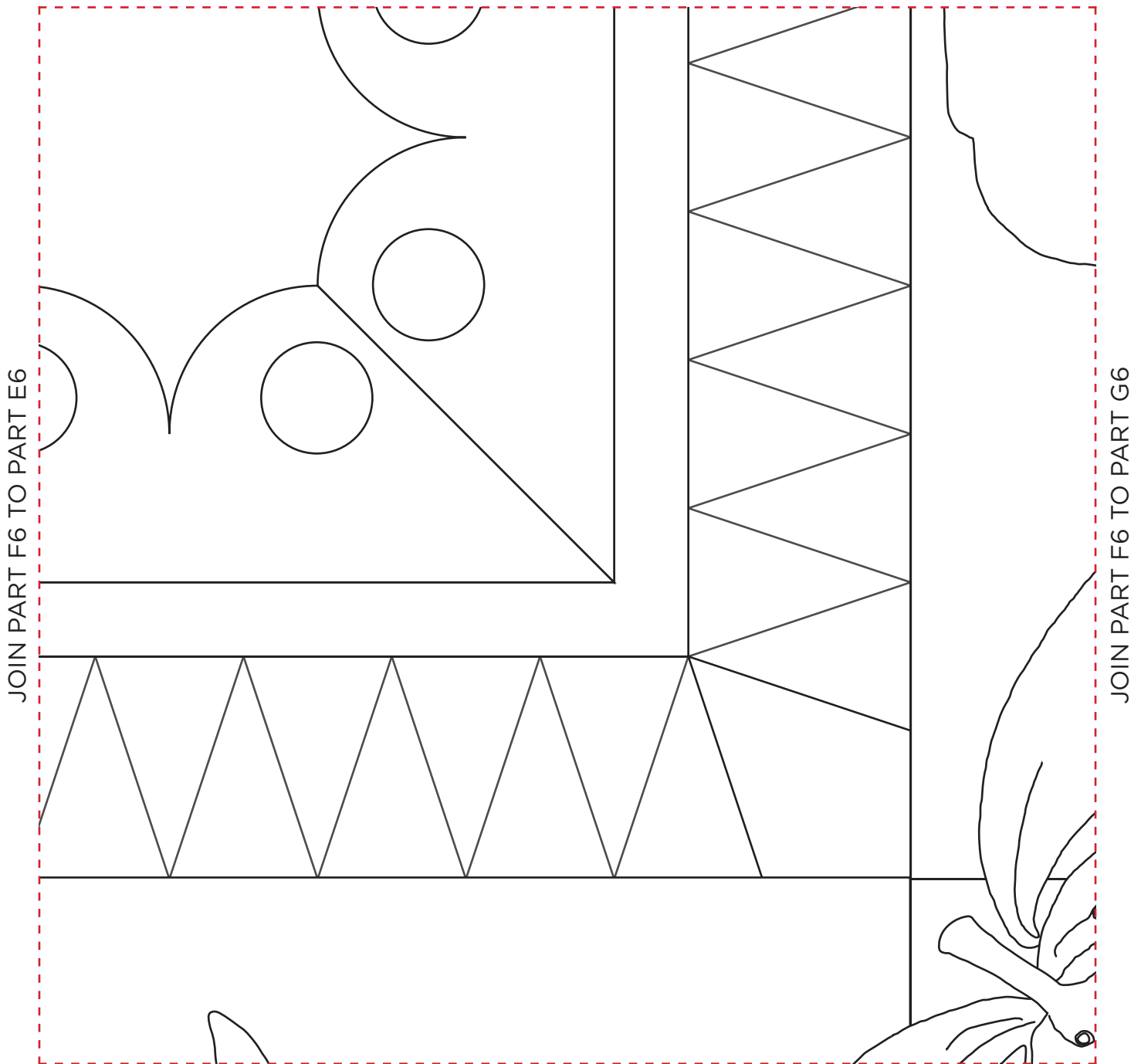

JOIN PART F6 TO PART F7

Thank you for making this project from Today's Quilter. The copyright for these templates belongs to the designer of the project. Please don't re-sell or distribute their work without permission. Please do not make any part of the templates or instructions available to others through your website or a third party website, or copy it multiple times without our permission. Copyright law protects creative work and unauthorised copying is illegal. We appreciate your help.

When printed
at the correct
size, this box
will measure
1in / 26mm
square

BEA'S GARDEN

Anne Varley page 26

APPLIQUÉ TEMPLATES AND LAYOUT



ACTUAL SIZE

PLEASE NOTE: Templates DO NOT include seam allowances.

PART G6

JOIN PART G6 TO PART G5



JOIN PART G6 TO PART G7

Thank you for making this project from Today's Quilter. The copyright for these templates belongs to the designer of the project. Please don't re-sell or distribute their work without permission. Please do not make any part of the templates or instructions available to others through your website or a third party website, or copy it multiple times without our permission. Copyright law protects creative work and unauthorised copying is illegal. We appreciate your help.

When printed
at the correct
size, this box
will measure
1in / 26mm
square

BEA'S GARDEN

Anne Varley page 26

APPLIQUÉ TEMPLATES AND LAYOUT



ACTUAL SIZE

PLEASE NOTE: Templates DO NOT include seam allowances.

PART H6

JOIN PART H6 TO PART H5

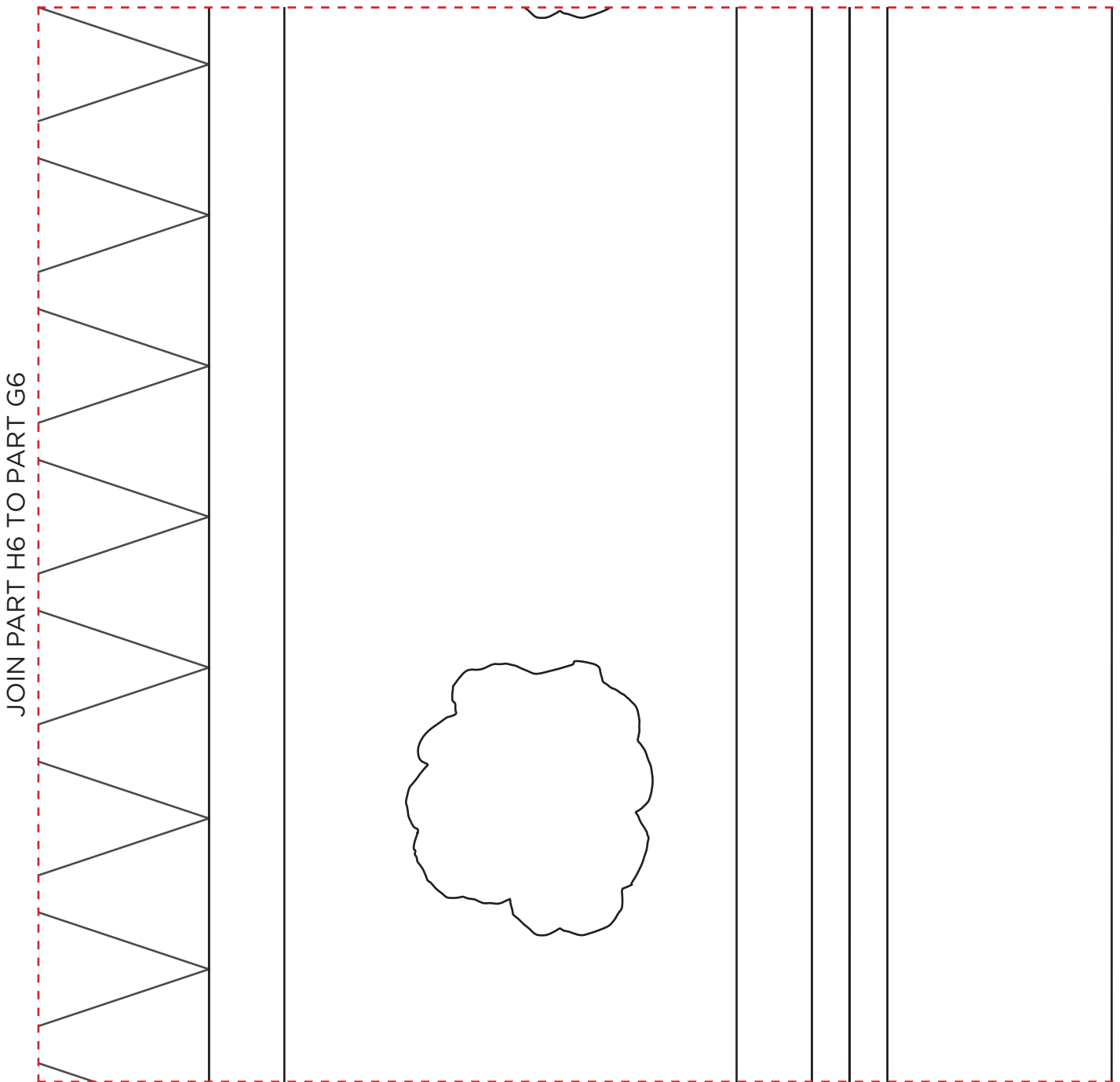

JOIN PART H6 TO PART H7

When printed
at the correct
size, this box
will measure
1in / 26mm
square

BEA'S GARDEN

Anne Varley page 26

APPLIQUÉ TEMPLATES AND LAYOUT



ACTUAL SIZE

PLEASE NOTE: Templates DO NOT include seam allowances.

PART A7

JOIN PART A7 TO PART A6

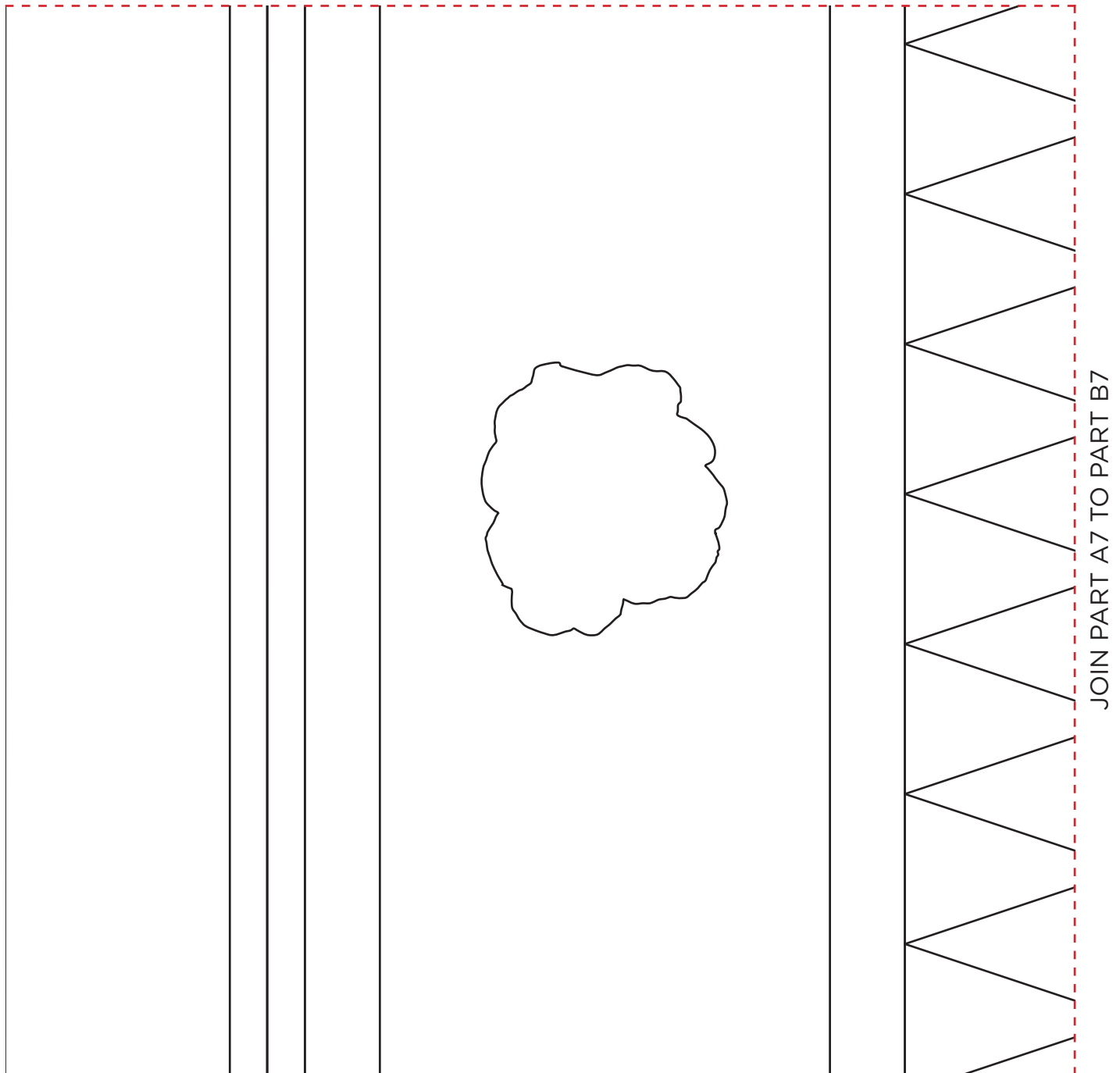

JOIN PART A7 TO PART A8

When printed
at the correct
size, this box
will measure
1in / 26mm
square

BEA'S GARDEN

Anne Varley page 26

APPLIQUÉ TEMPLATES AND LAYOUT



ACTUAL SIZE

PLEASE NOTE: Templates DO NOT include seam allowances.

PART B7

JOIN PART B7 TO PART B6

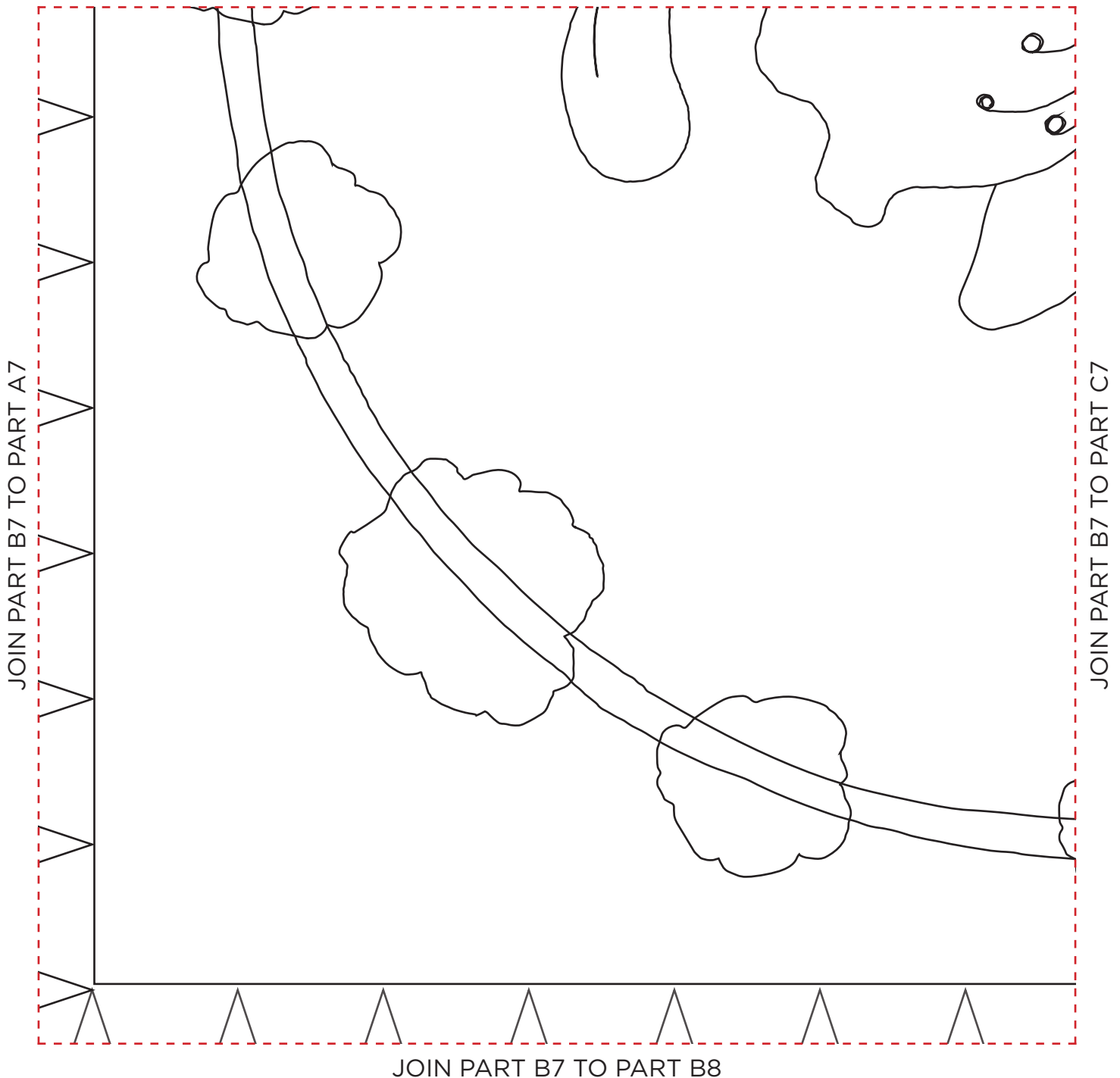

Thank you for making this project from Today's Quilter. The copyright for these templates belongs to the designer of the project. Please don't re-sell or distribute their work without permission. Please do not make any part of the templates or instructions available to others through your website or a third party website, or copy it multiple times without our permission. Copyright law protects creative work and unauthorised copying is illegal. We appreciate your help.

When printed
at the correct
size, this box
will measure
1in / 26mm
square

BEA'S GARDEN

Anne Varley page 26

APPLIQUÉ TEMPLATES AND LAYOUT



ACTUAL SIZE

PLEASE NOTE: Templates DO NOT include seam allowances.

PART C7

JOIN PART C7 TO PART C6

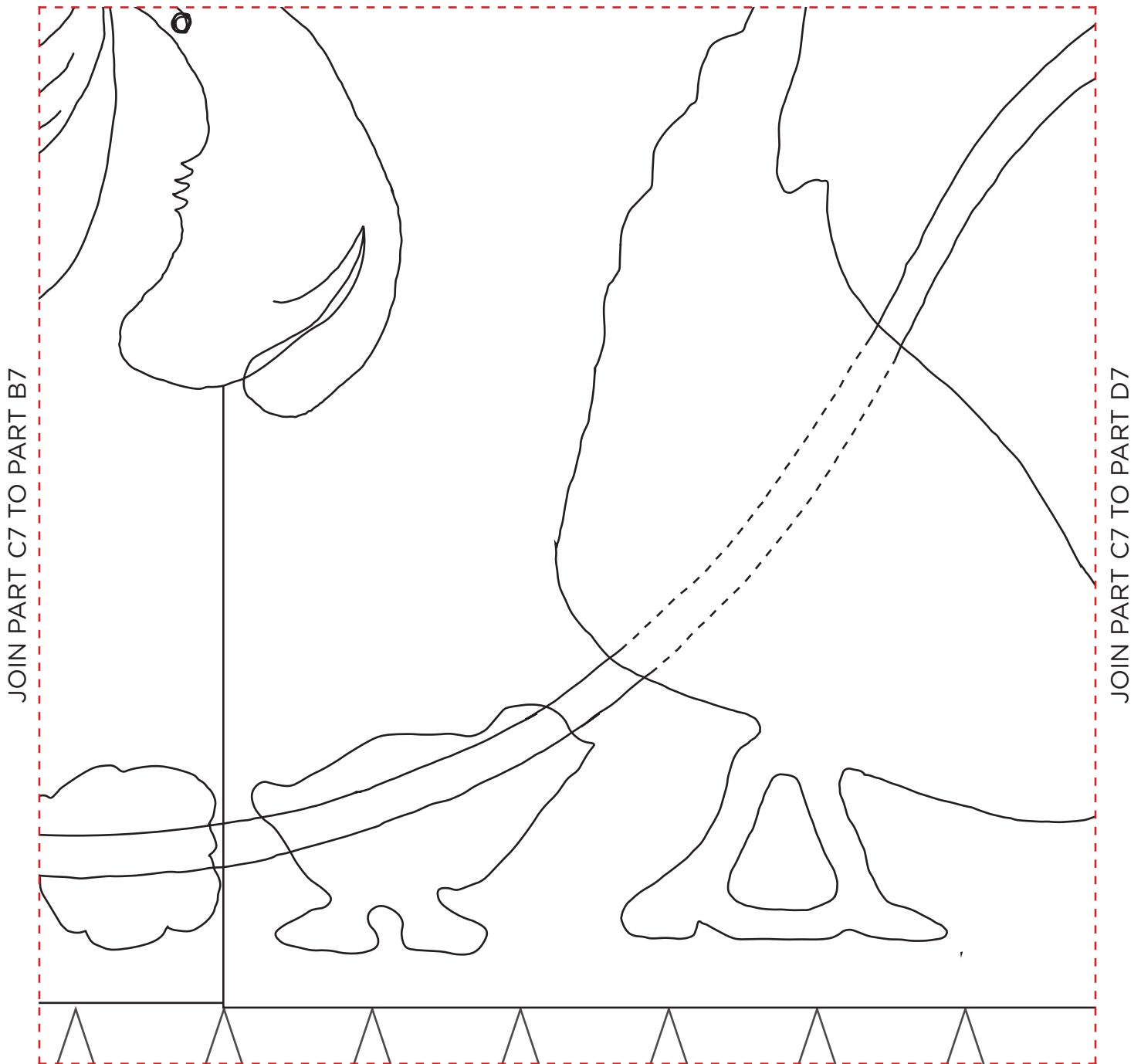

JOIN PART C7 TO PART C8

Thank you for making this project from Today's Quilter. The copyright for these templates belongs to the designer of the project. Please don't re-sell or distribute their work without permission. Please do not make any part of the templates or instructions available to others through your website or a third party website, or copy it multiple times without our permission. Copyright law protects creative work and unauthorised copying is illegal. We appreciate your help.

When printed
at the correct
size, this box
will measure
1in / 26mm
square

BEA'S GARDEN

Anne Varley page 26

APPLIQUÉ TEMPLATES AND LAYOUT



ACTUAL SIZE

PLEASE NOTE: Templates DO NOT include seam allowances.

PART D7

JOIN PART D7 TO PART D6

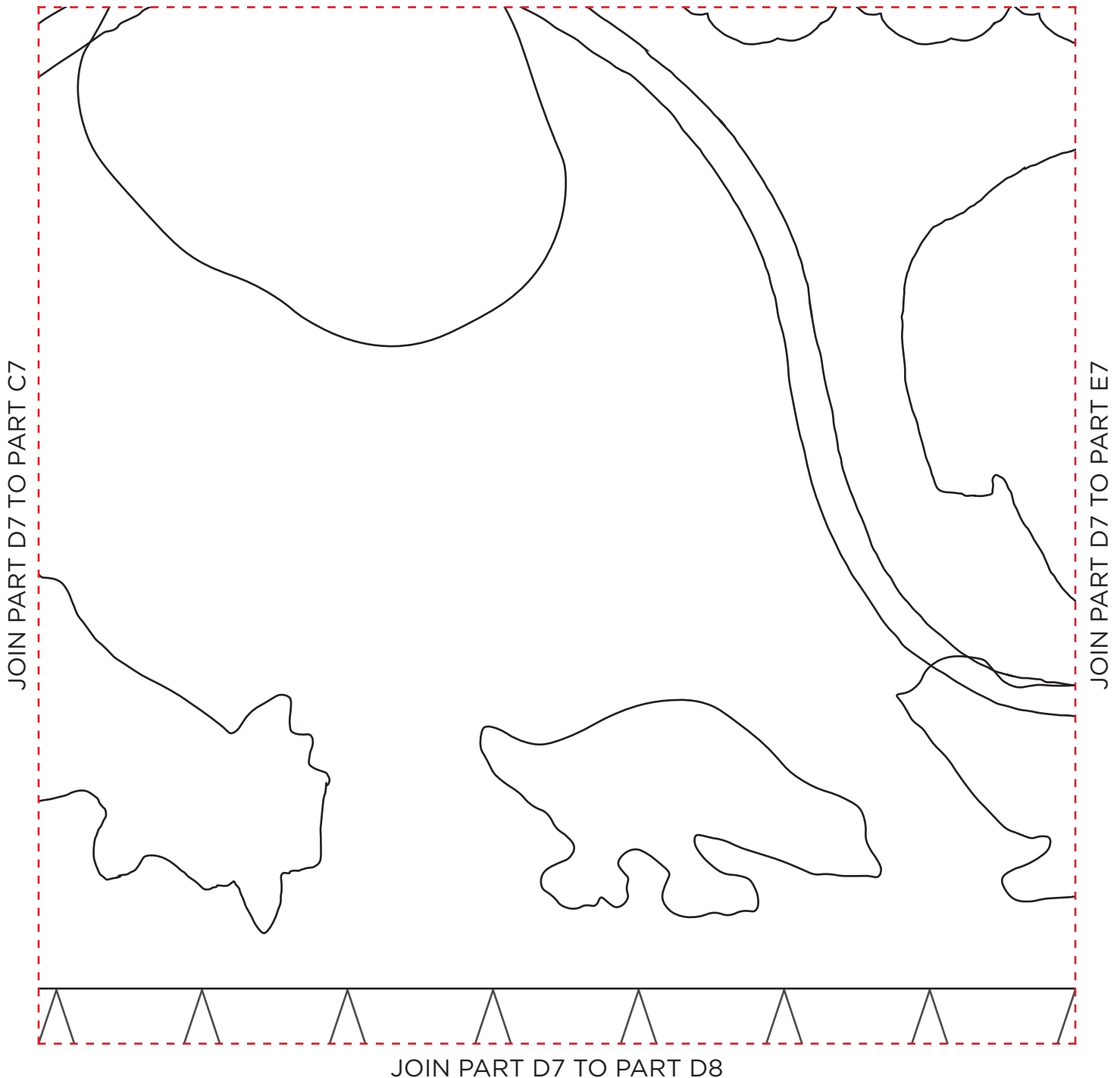

Thank you for making this project from Today's Quilter. The copyright for these templates belongs to the designer of the project. Please don't re-sell or distribute their work without permission. Please do not make any part of the templates or instructions available to others through your website or a third party website, or copy it multiple times without our permission. Copyright law protects creative work and unauthorised copying is illegal. We appreciate your help.

When printed
at the correct
size, this box
will measure
1in / 26mm
square

BEA'S GARDEN

Anne Varley page 26

APPLIQUÉ TEMPLATES AND LAYOUT



ACTUAL SIZE

PLEASE NOTE: Templates DO NOT include seam allowances.

PART E7

JOIN PART E7 TO PART E6

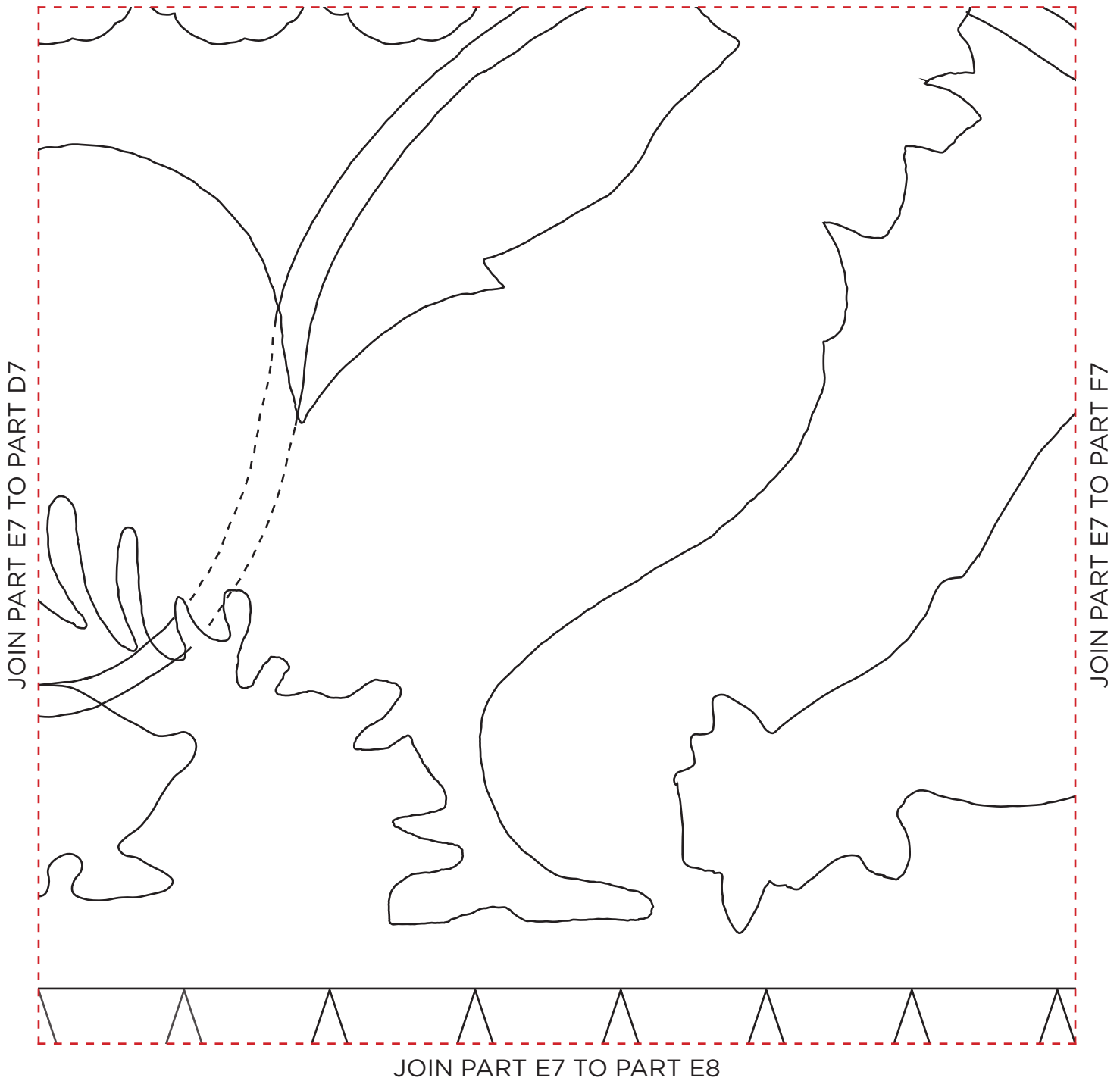

Thank you for making this project from Today's Quilter. The copyright for these templates belongs to the designer of the project. Please don't re-sell or distribute their work without permission. Please do not make any part of the templates or instructions available to others through your website or a third party website, or copy it multiple times without our permission. Copyright law protects creative work and unauthorised copying is illegal. We appreciate your help.

When printed
at the correct
size, this box
will measure
1in / 26mm
square

BEA'S GARDEN

Anne Varley page 26

APPLIQUÉ TEMPLATES AND LAYOUT



ACTUAL SIZE

PLEASE NOTE: Templates DO NOT include seam allowances.

PART F7

JOIN PART F7 TO PART F6

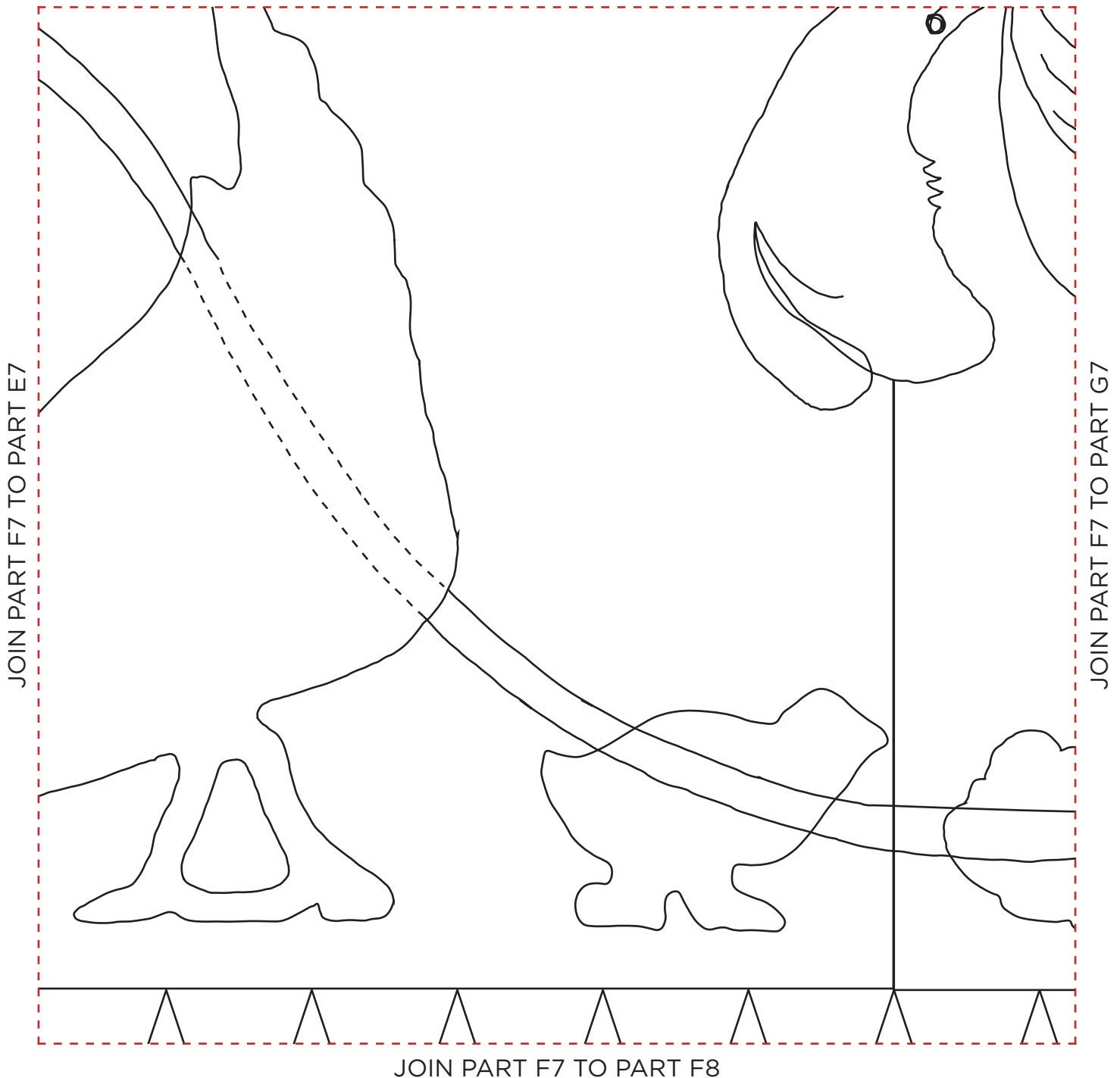

When printed
at the correct
size, this box
will measure
1in / 26mm
square

BEA'S GARDEN

Anne Varley page 26

APPLIQUÉ TEMPLATES AND LAYOUT



ACTUAL SIZE

PLEASE NOTE: Templates DO NOT include seam allowances.

PART G7

JOIN PART G7 TO PART G6

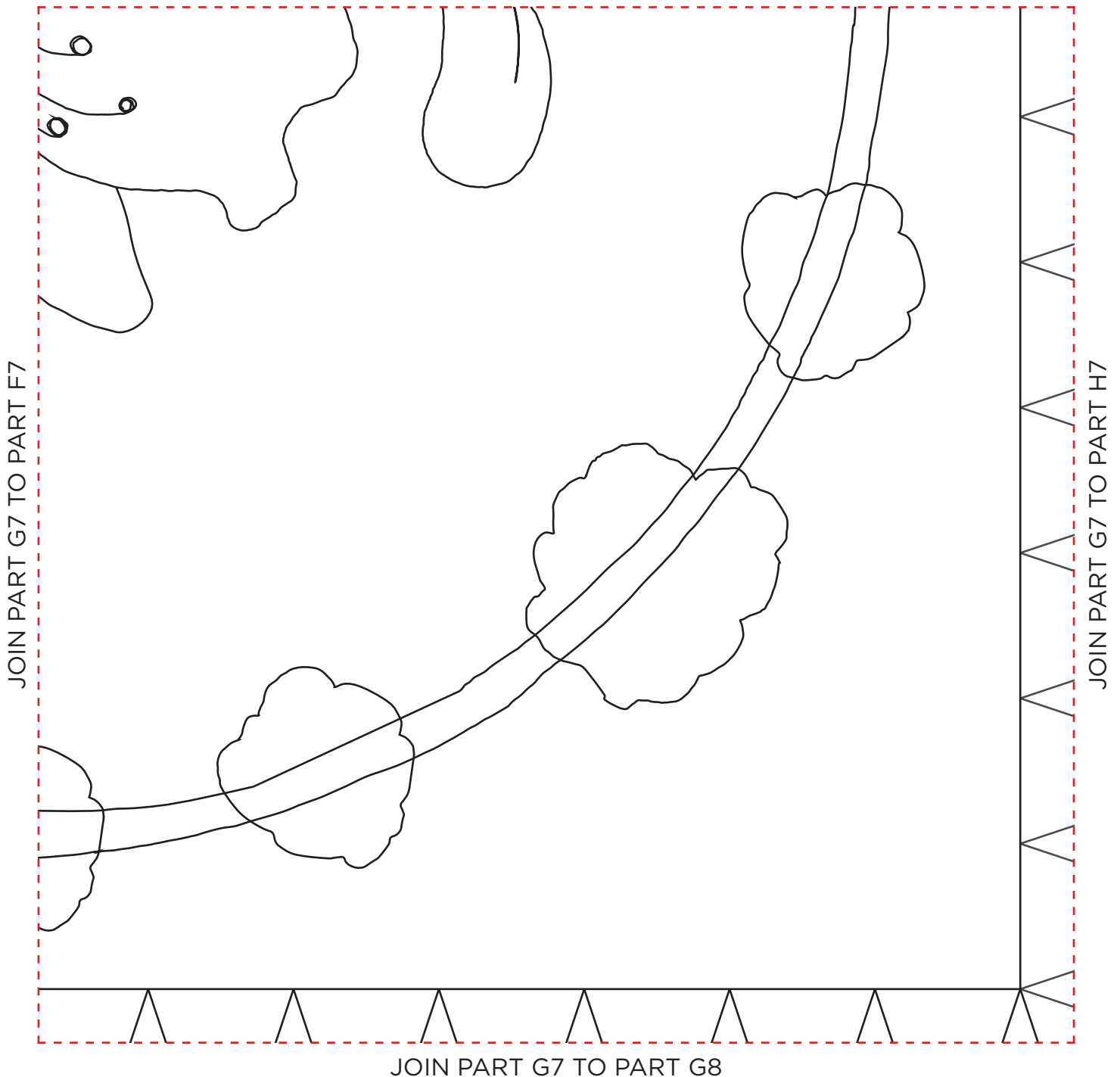

Thank you for making this project from Today's Quilter. The copyright for these templates belongs to the designer of the project. Please don't re-sell or distribute their work without permission. Please do not make any part of the templates or instructions available to others through your website or a third party website, or copy it multiple times without our permission. Copyright law protects creative work and unauthorised copying is illegal. We appreciate your help.

When printed
at the correct
size, this box
will measure
1in / 26mm
square

BEA'S GARDEN

Anne Varley page 26

APPLIQUÉ TEMPLATES AND LAYOUT



ACTUAL SIZE

PLEASE NOTE: Templates DO NOT include seam allowances.

PART H7

JOIN PART H7 TO PART H6

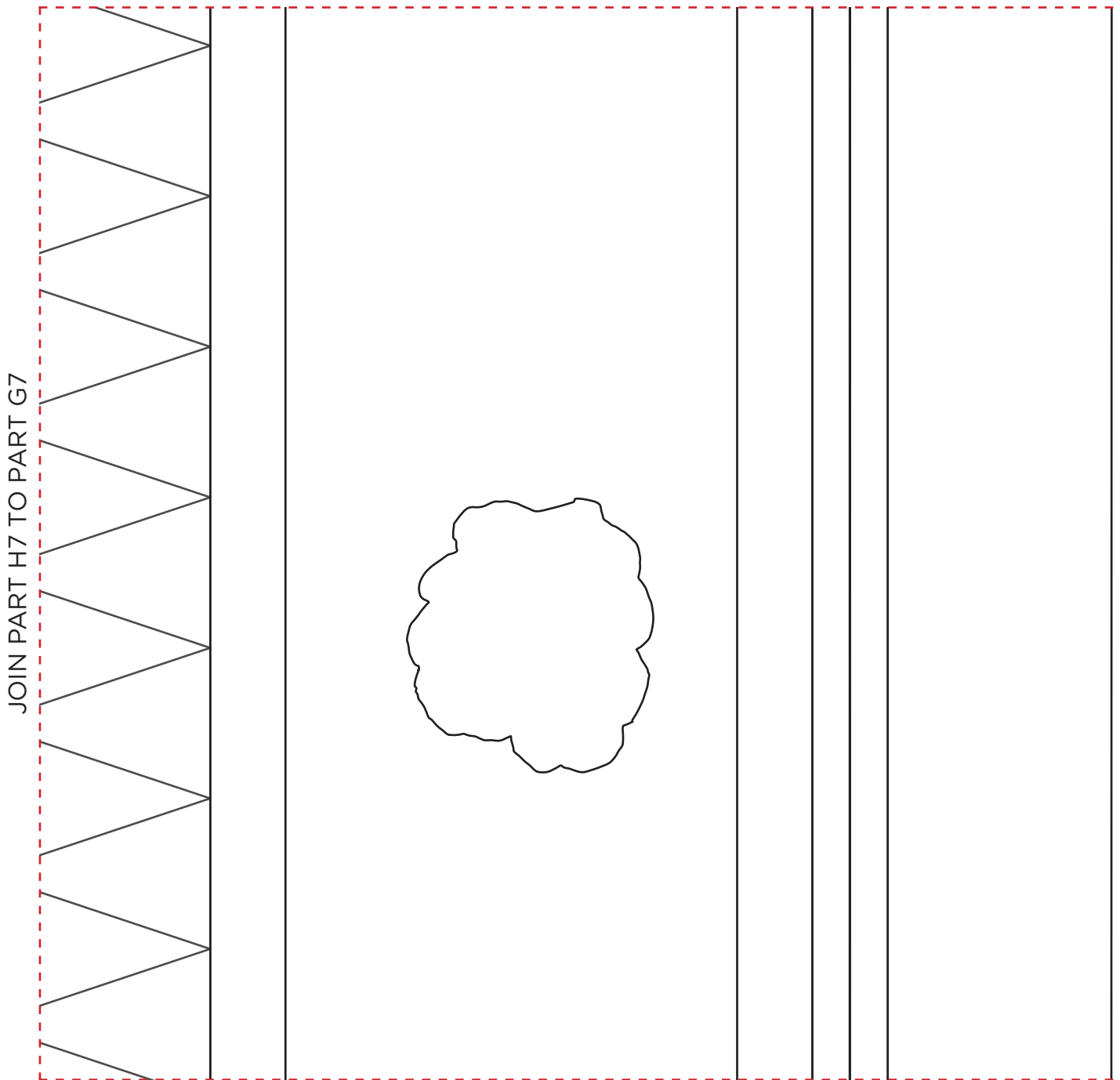

JOIN PART H7 TO PART H8

When printed
at the correct
size, this box
will measure
1in / 26mm
square

BEA'S GARDEN

Anne Varley page 26

APPLIQUÉ TEMPLATES AND LAYOUT



ACTUAL SIZE

PLEASE NOTE: Templates DO NOT include seam allowances.

PART A8

JOIN PART A8 TO PART A7

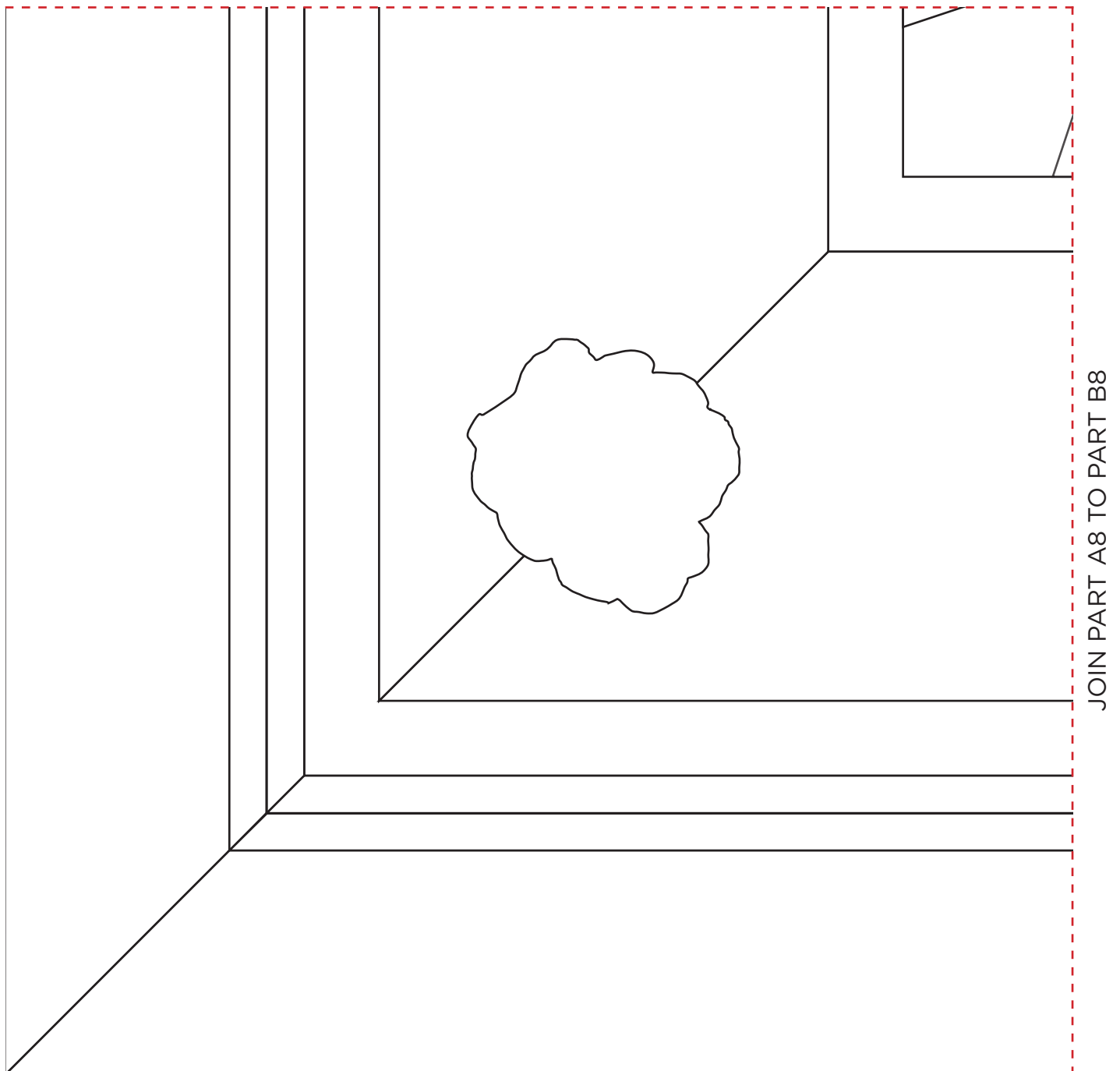

When printed
at the correct
size, this box
will measure
1in / 26mm
square

BEA'S GARDEN

Anne Varley page 26

APPLIQUÉ TEMPLATES AND LAYOUT



ACTUAL SIZE

PLEASE NOTE: Templates DO NOT include seam allowances.

PART B8

JOIN PART B8 TO PART B7

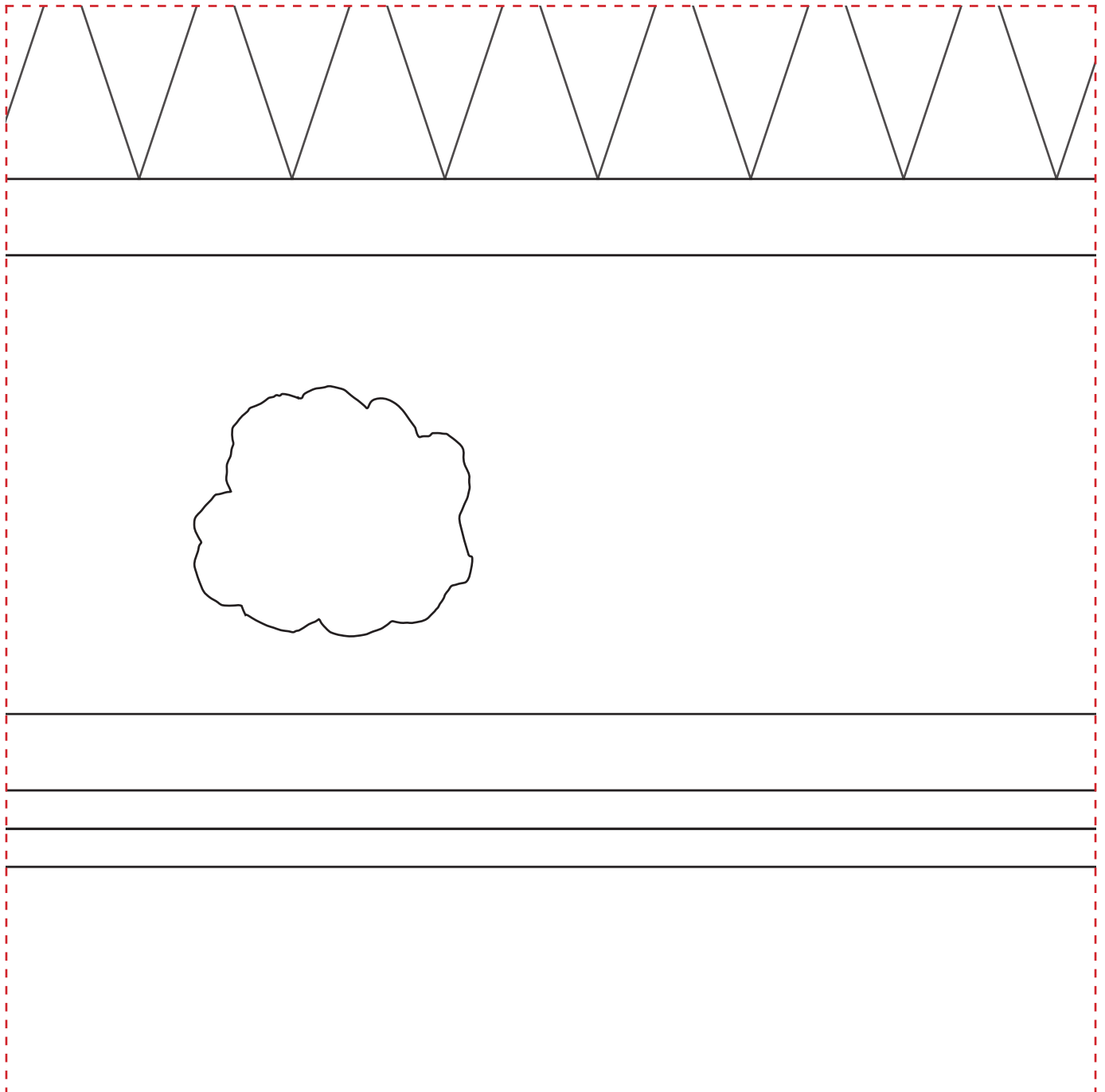

When printed at the correct size, this box will measure 1in / 26mm square

BEA'S GARDEN

Anne Varley page 26

APPLIQUÉ TEMPLATES AND LAYOUT



ACTUAL SIZE

PLEASE NOTE: Templates DO NOT include seam allowances.

PART C8

JOIN PART C8 TO PART C7

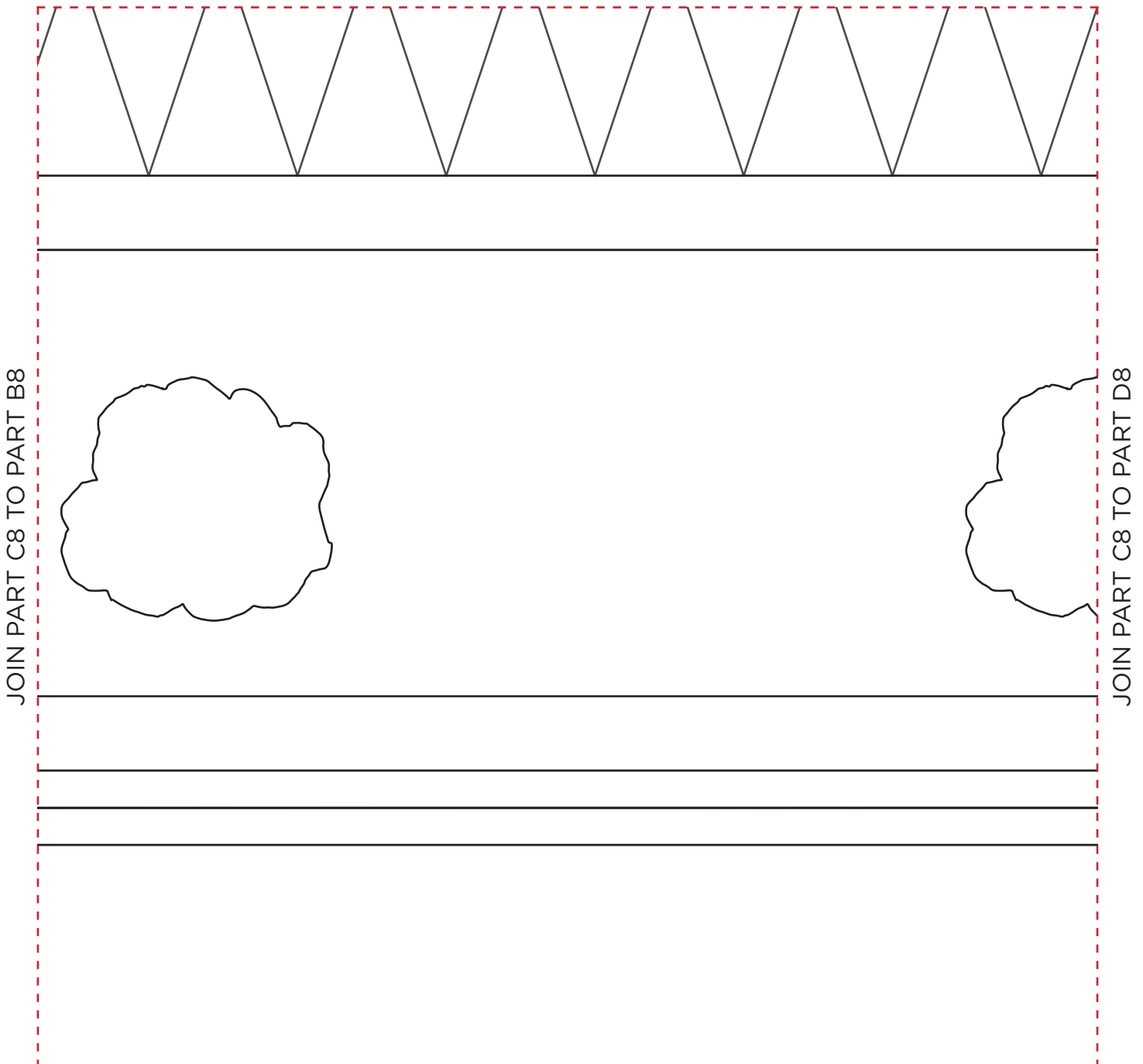

When printed
at the correct
size, this box
will measure
1in / 26mm
square

BEA'S GARDEN

Anne Varley page 26

APPLIQUÉ TEMPLATES AND LAYOUT



ACTUAL SIZE

PLEASE NOTE: Templates DO NOT include seam allowances.

PART D8

JOIN PART D8 TO PART D7

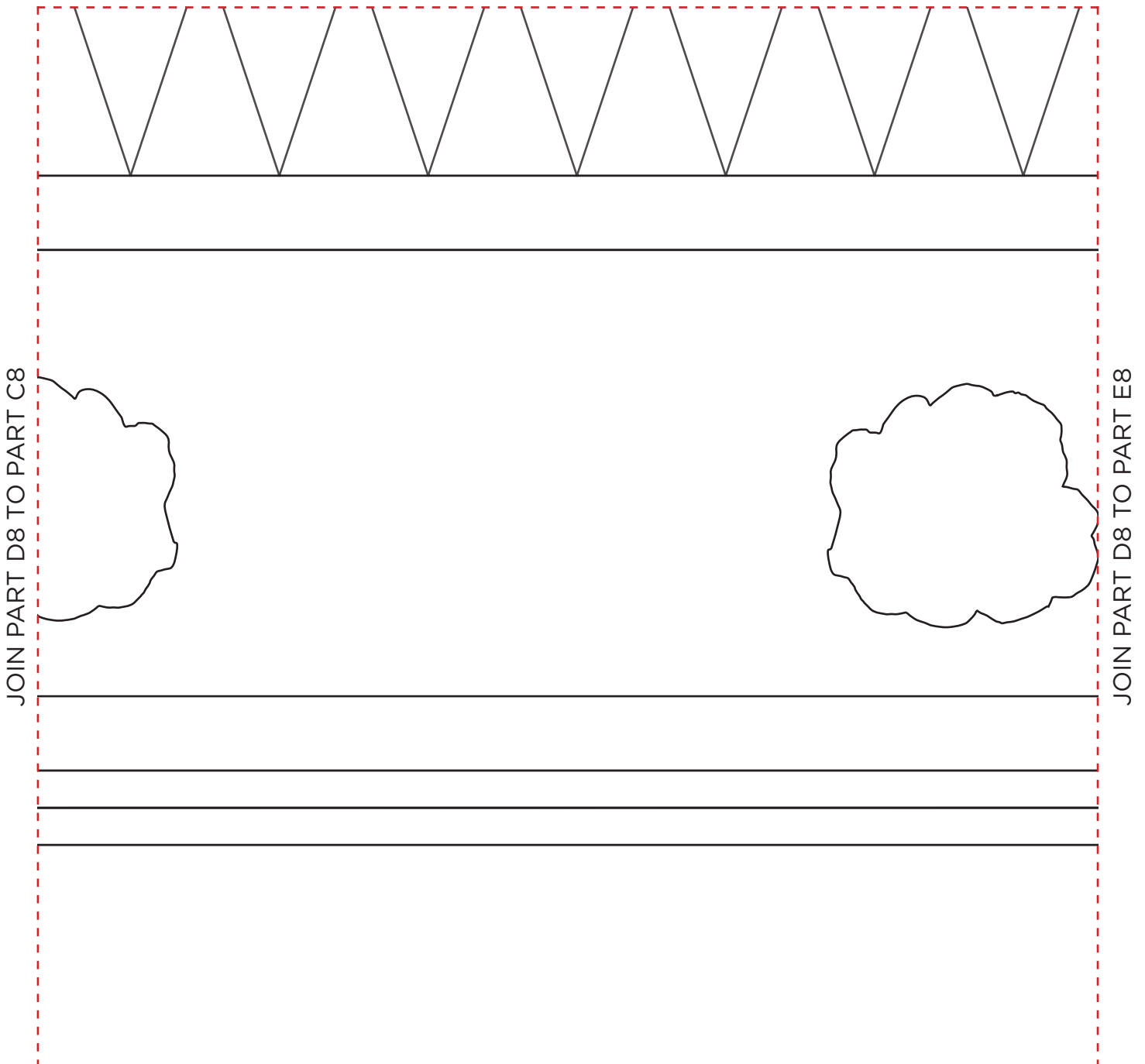

When printed
at the correct
size, this box
will measure
1in / 26mm
square

BEA'S GARDEN

Anne Varley page 26

APPLIQUÉ TEMPLATES AND LAYOUT



ACTUAL SIZE

PLEASE NOTE: Templates DO NOT include seam allowances.

PART E8

JOIN PART E8 TO PART E7

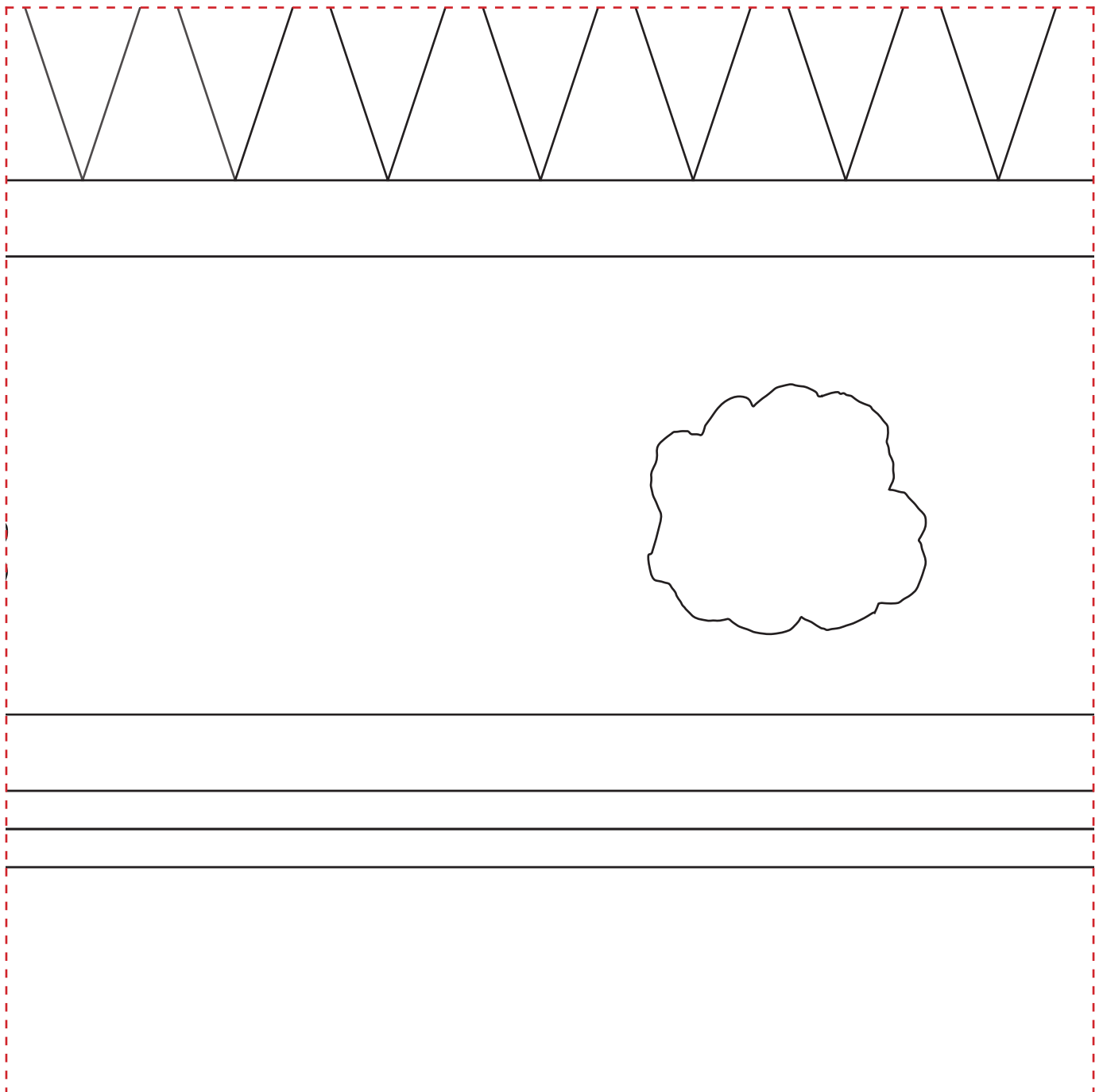

When printed
at the correct
size, this box
will measure
1in / 26mm
square

BEA'S GARDEN

Anne Varley page 26

APPLIQUÉ TEMPLATES AND LAYOUT



ACTUAL SIZE

PLEASE NOTE: Templates DO NOT include seam allowances.

PART F8

JOIN PART F8 TO PART F7

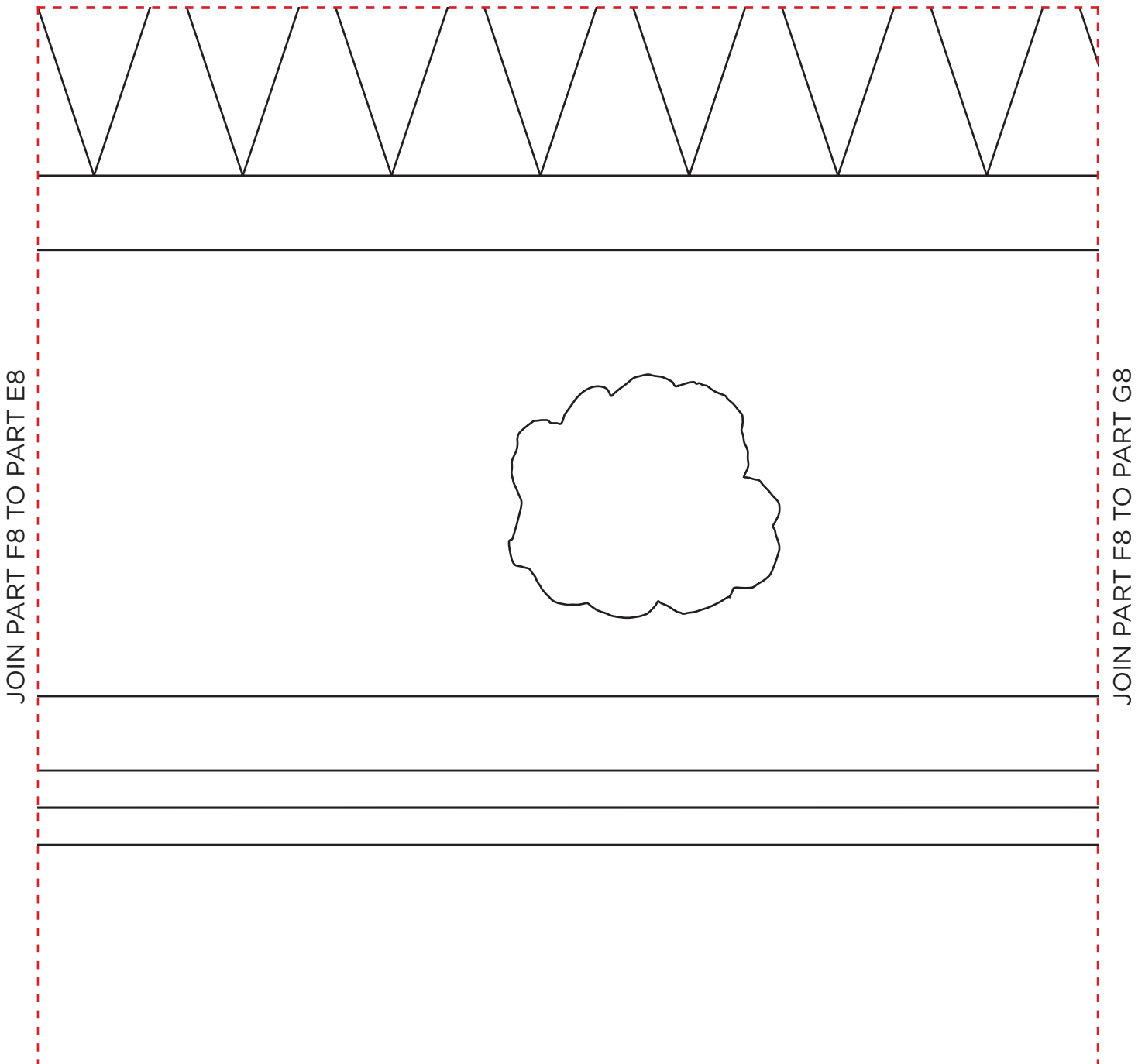

When printed
at the correct
size, this box
will measure
1in / 26mm
square

BEA'S GARDEN

Anne Varley page 26

APPLIQUÉ TEMPLATES AND LAYOUT



ACTUAL SIZE

PLEASE NOTE: Templates DO NOT include seam allowances.

PART G8

JOIN PART G8 TO PART G7

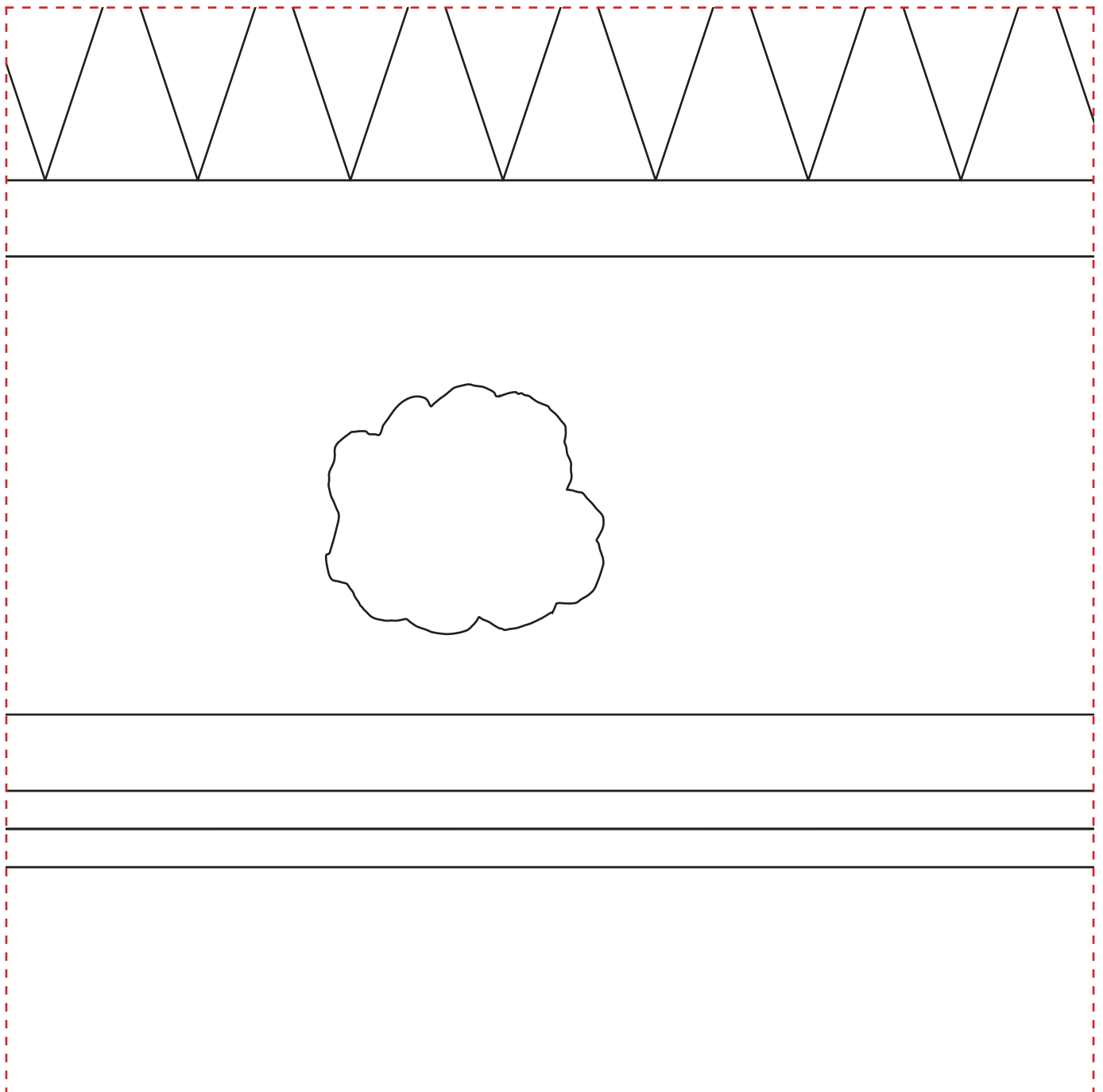

When printed
at the correct
size, this box
will measure
1in / 26mm
square

BEA'S GARDEN

Anne Varley page 26

APPLIQUÉ TEMPLATES AND LAYOUT



ACTUAL SIZE

PLEASE NOTE: Templates DO NOT include seam allowances.

PART H8

JOIN PART H8 TO PART H7

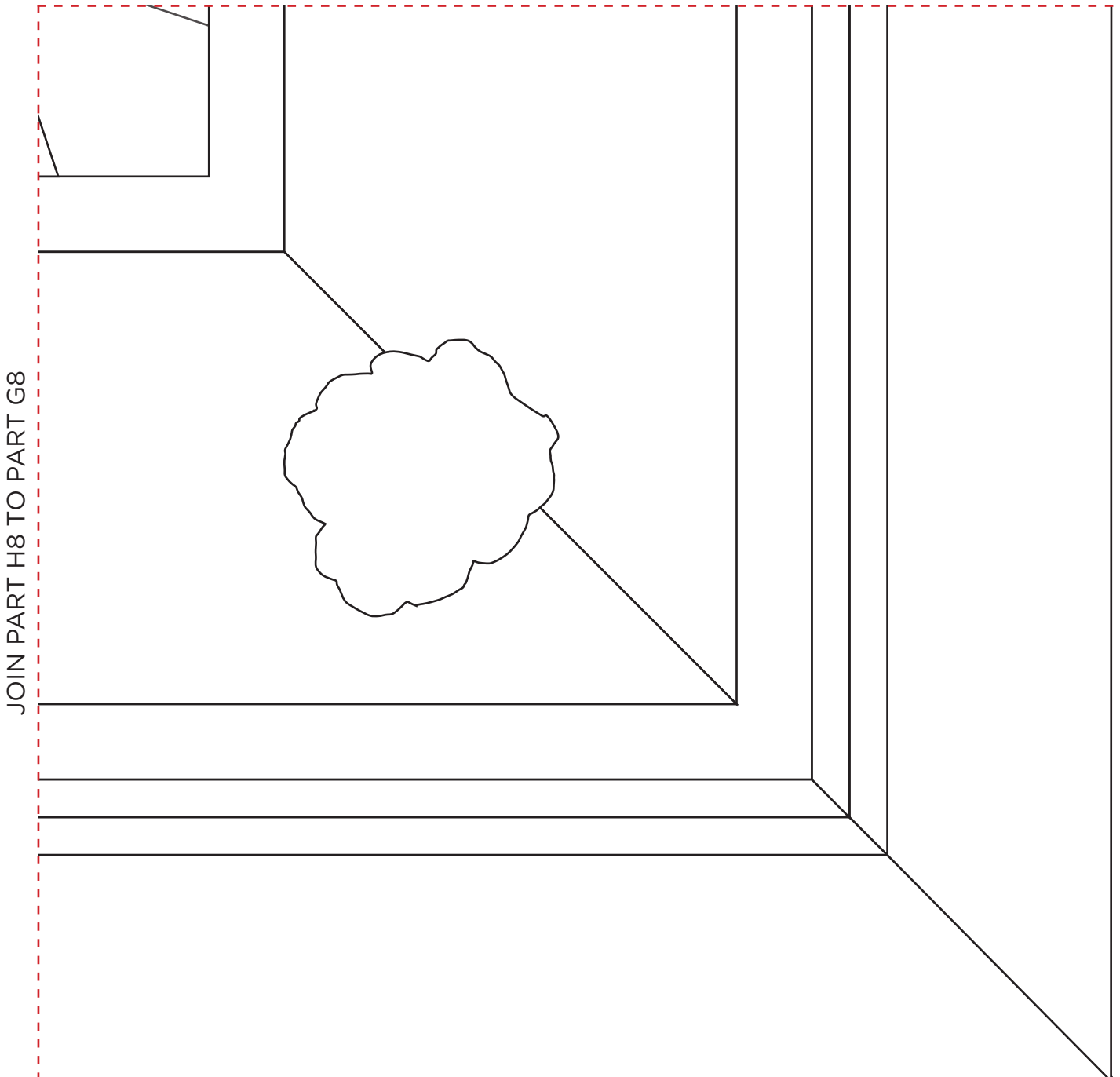

When printed
at the correct
size, this box
will measure
1in / 26mm
square

BEA'S GARDEN

Anne Varley page 26

APPLIQUÉ LAYOUT PLAN

PLEASE NOTE: Layout plan is for reference
only

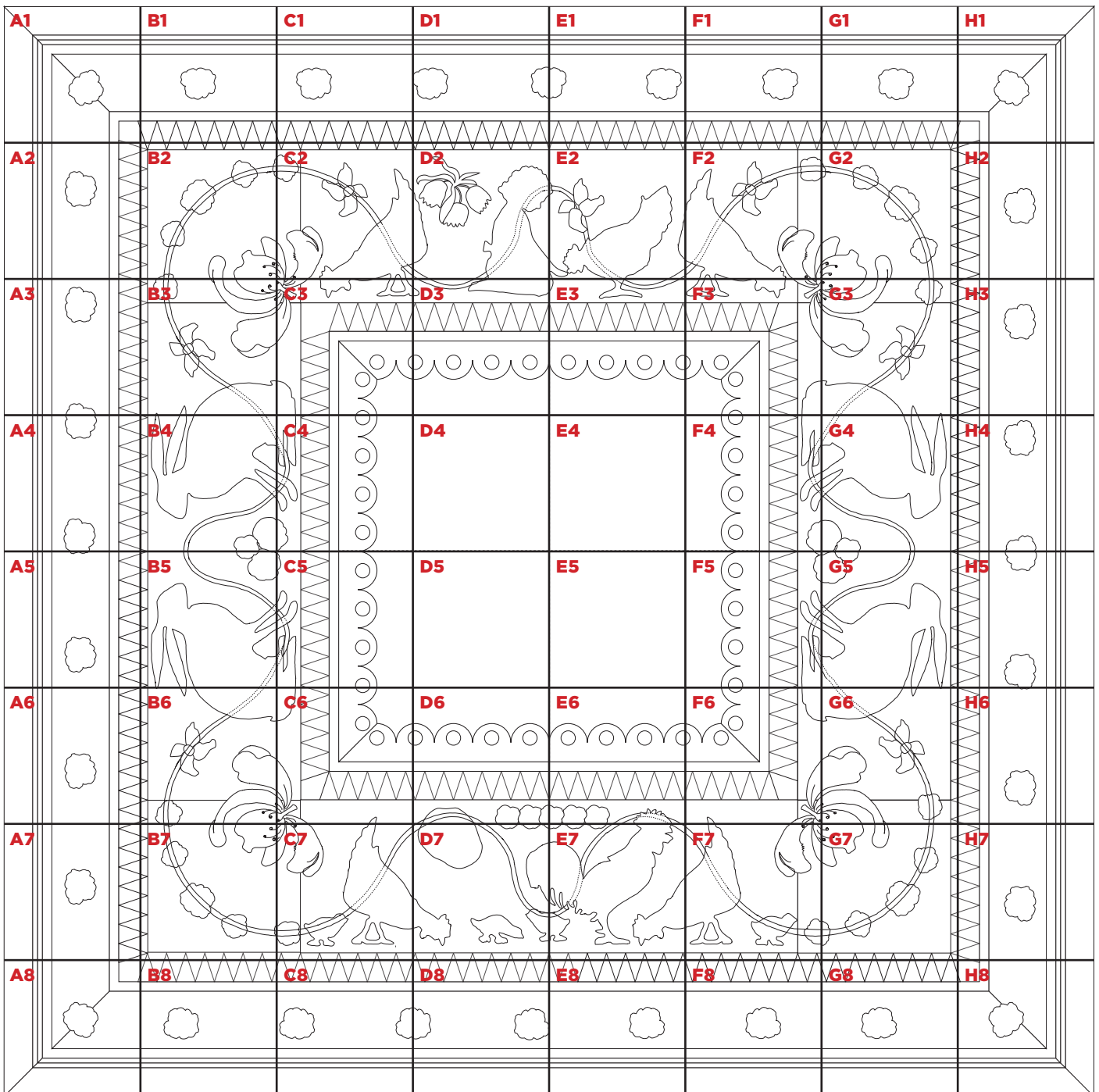

TRY 6 ISSUES FOR £12*

WHEN YOU SUBSCRIBE TODAY!



TODAY'S QUILTER – your favourite magazine with a fresh take on traditional quilting

—★—
PROJECTS by stars of the quilt world

—★—
BEAUTIFUL PHOTOGRAPHY that showcases stunning quilt creations

Subscribe online, it's quick and easy!

Visit www.buysubscriptions.com/TQHA23

or call **03330 162 154[†]** QUOTE CODE **TQHA23**

Lines are open 8am-6pm weekdays and 9am-1pm Saturday (orders only on Saturday)

*All savings are calculated as a percentage of Basic Annual Rate. The UK Basic annual rate is £91.87, which includes event issues (issues charged higher than standard cover price) published in a 12 month period. Your subscription will start with the next available issue. This offer is a special introductory offer for new UK print subscribers paying by direct debit only. If you cancel within 2 weeks of receiving your 5th issue you will pay no more than £12. Otherwise your subscription will continue at £30.49 every 6 issues. Full details of the Direct Debit guarantee are available upon request. **Offer ends: 31st December 2023.** [†]UK calls will cost the same as other standard fixed line numbers (starting 01 or 02) and are included as part of any inclusive or free minutes allowances (if offered by your phone tariff). Outside of free call packages call charges from mobile phones will cost between 3p and 55p per minute.